

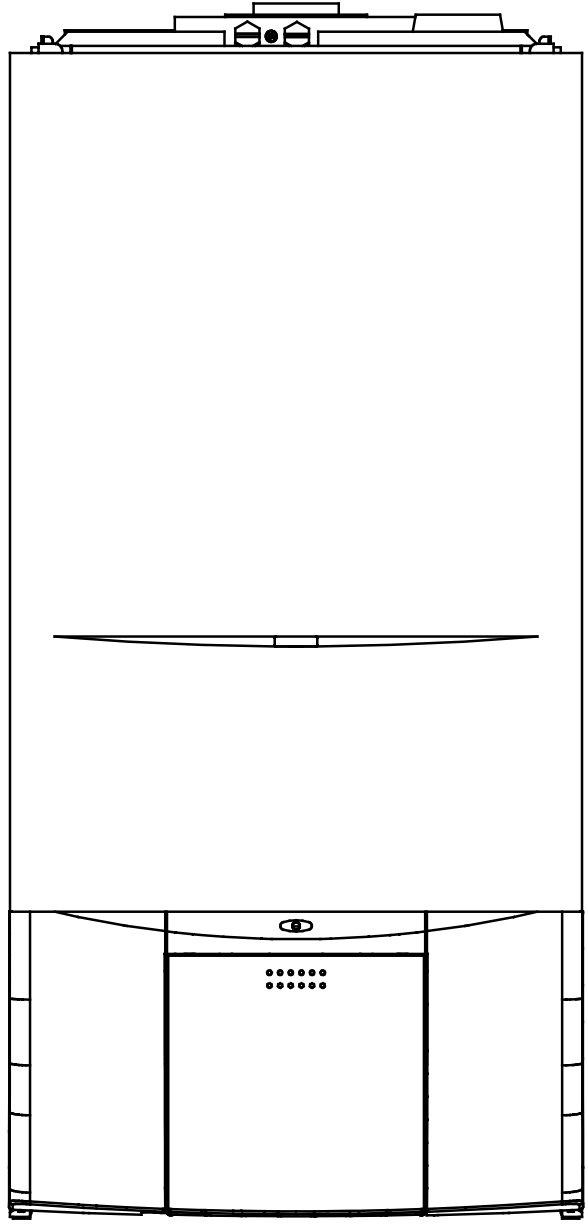

Syntesi



User Instructions



**THESE INSTRUCTIONS
TO BE RETAINED
BY USER**



*The code of practice for the installation,
commissioning & servicing of central heating systems*

THIS DOCUMENT HAS BEEN PROVIDED BY



heatingspares247.com

PLEASE VISIT WWW.HEATINGSPPARES247.COM FOR FURTHER INFORMATION AND GENUINE PARTS & SPARES AT LOW PRICES

INTRODUCTION

Contents

		Page
Introduction	Dear customer	1
	Do's and don'ts	1
Things you should know	1.1 Gas appliances	3
	1.2 Electrical supply	3
	1.3 Guarantee registration card	3
	1.4 Benchmark log book	3
	1.5 How does it work?	3
	1.6 Additional features	3
	1.7 Dimensions	3
	1.8 Clearances	3
	1.9 Filling valve	4
Getting started	2.1 Before switching on	4
	2.2 Appliance controls	4
	2.3 Lighting the boiler	4
How to...	3.1 Top-up the system	5
	3.2 Reset the appliance	5
	3.3 Understand the diagnostic fault codes	5
	3.4 Shut down the system for short periods	5
	3.5 Shut down the system for long periods	5
	3.6 Care for the appliance	5
What if...	4.1 I suspect a gas leak	6
	4.2 I frequently have to top-up the system	6
	4.3 The status LED is flashing Red	6
	4.4 The appliance is due its annual service	6
	4.5 I need to call an engineer	6
Setting the Vokera....	Remote-control (RC05)	6
	Mechanical clock	9
	Digital clock	9

Dear Customer

Your Syntesi boiler has been designed to meet and exceed the very latest standards in gas central heating technology and if cared for, will give years of reliable use and efficiency. Please therefore take some time to read these instructions carefully.

Do's and Don'ts

- **Do** ensure that the system pressure is periodically checked
- **Do** ensure that you know how to isolate the appliance in an emergency
- **Do** ensure that you are familiar with the appliance controls
- **Do** ensure that your installer has completed the appliance log book
- **Do not** attempt to remove the appliance casing or gain internal access
- **Do not** hang clothes etc. over the appliance
- **Do not** forget to have the appliance serviced annually
- **Do** ensure that your installer or engineer uses only genuine Vokera spare parts

INTRODUCTION

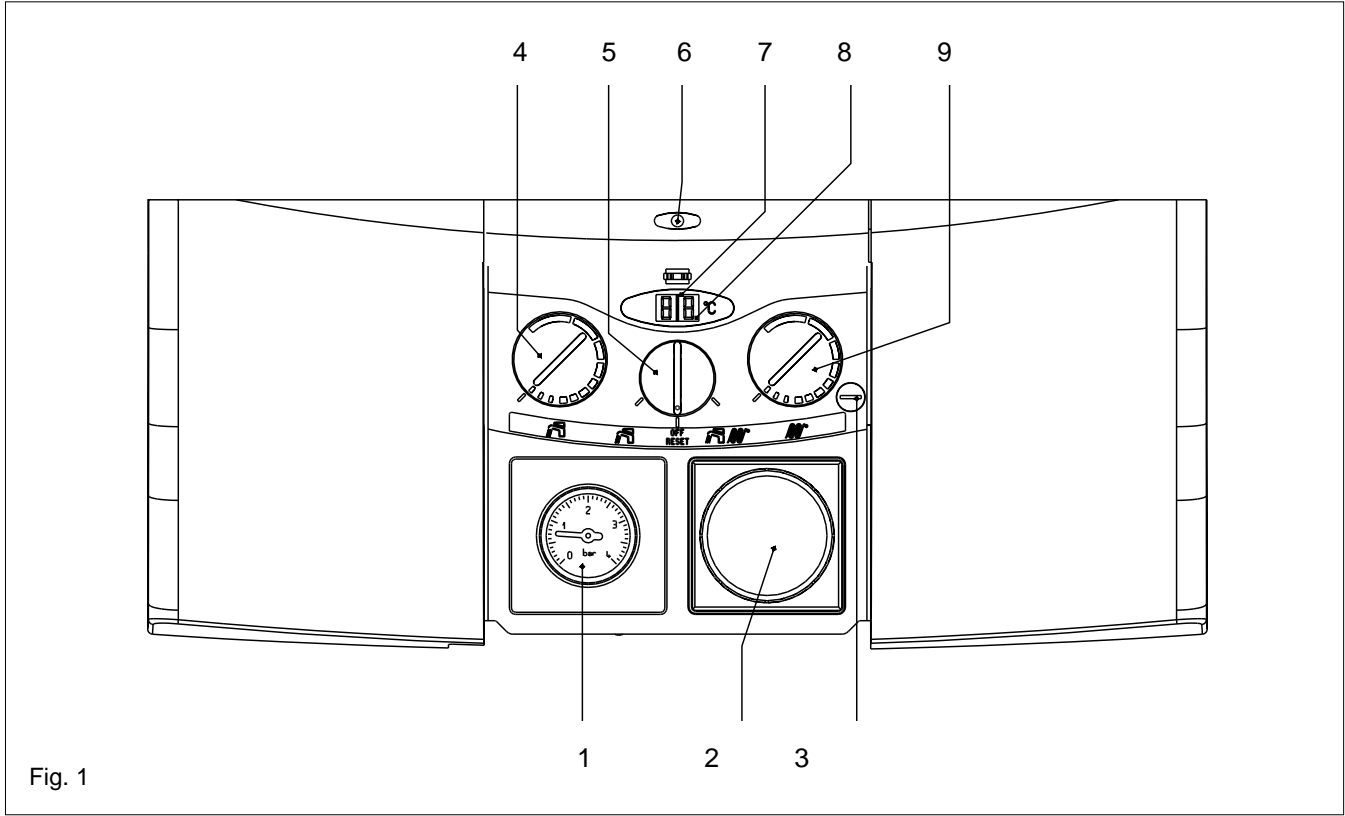

Fig. 1

- 1. Pressure gauge
- 2. Clock aperture
- 3. N/A
- 4. Hot Water temperature selector
- 5. Mode selector switch
- 6. Status LED
- 7. Digital display
- 8. Heating temperature selector
- 9. DHW request LED

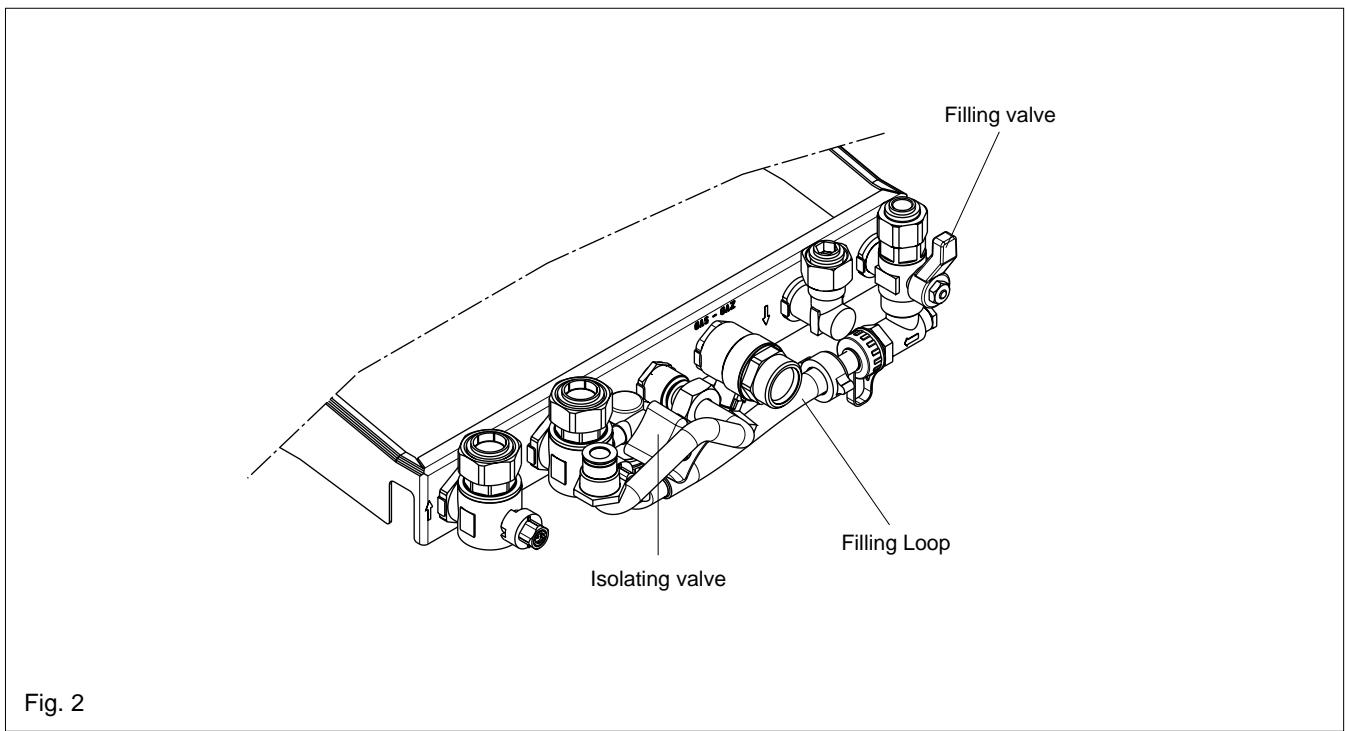

Fig. 2

THINGS YOU SHOULD KNOW

1.1 GAS APPLIANCES

Gas Safety (Installations and Use) Regulations. In the interests of your safety and that of others it is a legal requirement that all gas appliances are installed and correctly maintained by a competent person and in accordance with the latest regulations.

1.2 ELECTRICAL SUPPLY

Please ensure that this appliance has been properly connected to the electrical supply by means of a double pole isolator or un-switched socket, and that the correct size of fuse (3 amp) has been fitted.

WARNING:

THIS APPLIANCE MUST BE EARTHED!

1.3 GUARANTEE REGISTRATION CARD

Please take the time to fill out your guarantee registration card. The completed warranty card should be posted within 30 days of installation.

1.4 BENCHMARK LOG BOOK

The **Benchmark** Log Book is supplied with your boiler. This important document must be completed during the installation/commissioning of your boiler. All CORGI Registered Installers carry a CORGI ID card and have a registration number. Both should be recorded in your **Benchmark** Log Book. You can check your installer by calling CORGI direct on 01256 372300. Failure to install and commission the appliance in accordance with the manufacturers instructions may invalidate the warranty. This does not affect your statutory rights.

1.5 HOW DOES IT WORK?

Your Syntesi boiler is a combined central heating and hot water boiler. The Syntesi supplies heated water to your radiators and provides hot water when a hot water outlet is opened.

Your Syntesi boiler can be controlled by several different types of controls such as:

- Integral time clock
- External time clock
- Vokera remote-control
- Programmable room thermostat

It's therefore necessary to ensure that these instructions are read in conjunction with the instructions supplied with the relevant control.

The Syntesi lights electronically and does not have a pilot light.

In the unlikely event of a fault developing with your boiler, the supply of gas to the burner will be terminated automatically.

1.6 ADDITIONAL FEATURES

Your Syntesi boiler includes some of the latest features that have been designed to ensure continued safety and reliability of the appliance. These include:

- appliance frost protection
- hot water pre-heat
- pump, valve actuator & fan anti-block

- diagnostic fault codes
- LED status indicator
- digital display

FROST PROTECTION

Your Syntesi boiler will automatically operate to minimise the risk of frost damage to the boiler itself. The frost protection device will be disabled should the power supply to the boiler be disrupted.

HOT WATER PRE-HEAT

The Syntesi's pre-heat facility ensures that the boiler responds quickly to any hot water requests.

PUMP, ACTUATOR, & FAN ANTI-BLOCK

When the boiler has not been used for more than 24 hours, the pump, fan & valve actuator, are energised for a few seconds to ensure that they do not stick or jam. This function will be disabled should the power supply to the boiler be disrupted.

DIAGNOSTIC FAULT CODES

In the unlikely event of a fault developing, the boiler displays a unique fault code that helps identify where the fault lies.

LED STATUS INDICATOR

The Syntesi is equipped with an LED status indicator that gives a visual indication of whether the boiler is working normally or has developed a fault.

DIGITAL DISPLAY

The digital display shows the current temperature of the hot water or heating outlet (depending on mode of operation). In addition, it also displays a unique fault code in the unlikely event of the boiler malfunctioning.

1.7 DIMENSIONS

HEIGHT	820mm
WIDTH	400-500mm depending on model
DEPTH	355mm

1.8 CLEARANCES REQUIRED

ABOVE	150mm
BELOW	150mm
SIDES	12mm
FRONT	600mm

1.9 FILLING VALVE

The filling valve is located underneath the boiler. The filling valve lever has 3 positions:

- normal operating position
- closed position
- filling position.

The valve lever should never be turned to the filling position unless the filling loop has been connected and the system pressure requires topping-up (see 3.1).

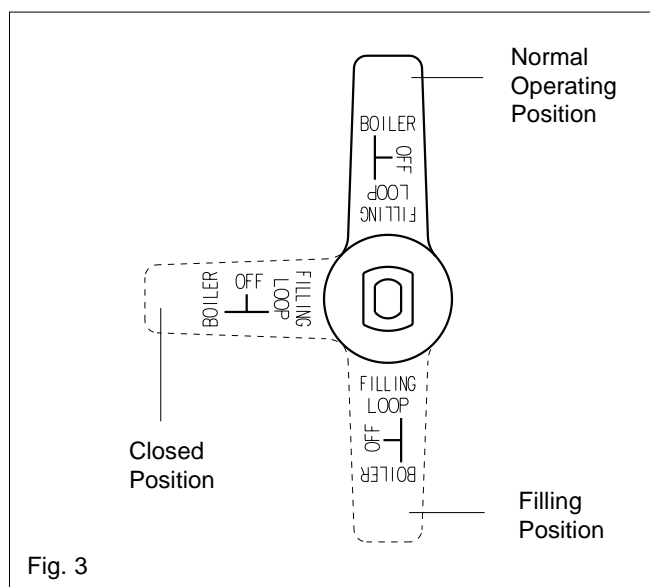

Fig. 3

GETTING STARTED

2.1 BEFORE SWITCHING ON

Before switching the appliance on please familiarise yourself with:

- how to isolate the appliance from the gas, water and electricity supplies
- how to check and top-up – if necessary – the system water pressure
- the time clock or boiler control
- any external thermostats and their functions
- the appliance controls.

2.2 APPLIANCE CONTROLS (see fig. 1)

The appliance controls are concealed behind the front flap. To gain access to the controls simply press the top centre of the flap, release and pull downwards.

The appliance has a mode selector switch, variable thermostats for controlling the temperature of the heating flow outlet and the hot water outlet, system pressure gauge and an aperture for an integral clock. The mode selector switch has three positions:

- hot water only
- off
- heating & hot water

The variable hot water thermostat allows you to set the temperature of the water to your hot water taps between 37.5°C (min) and 65°C (max).

The appliance will have been commissioned by your installer to deliver hot water at both a reasonable temperature and flow rate.

Should you wish to increase the temperature of the hot water and the hot water thermostat is already set at maximum, simply reduce the flow of water as it comes out of the tap. Please consult your installer for further advice if required.

The variable heating thermostat allows you to set the temperature of the water to your radiators between 40°C (min) and 80°C (max).

The pressure gauge shows the current pressure of the system, the gauge should be set between 1 and 1.5 bar. When the appliance is operating the gauge may rise or fall slightly, this is quite

normal. The minimum permissible level for the safe and efficient operation of the appliance is 0.5 bar. Should the pressure fall below 0.5 bar, the boiler shuts off automatically.

Depending on the type of controls specified by your installer you may have an integral Vokera time clock or the Vokera remote control fitted, if so, supplementary instructions can be found at the back of this booklet. If an external time clock has been fitted, please refer to the instructions supplied with such.

2.3 LIGHTING THE BOILER

Ensure the gas and electrical supplies to the boiler are turned on.

Turn the mode switch to the 'heating & hot water' position. The status indicator should be 'Green' if the status indicator is flashing 'Red' refer to 3.2. Refer to the particular instructions for the type of time clock or control fitted and ensure there is a demand for heating. If there is a room thermostat you should ensure that this is also calling for heat. When there is a demand for heating via the above controls the boiler will go through an ignition sequence, whereby the burner will light.

If the appliance fails to ignite during the ignition sequence, allow a period of two minutes before re-setting.

To adjust the output temperature of the appliance turn the thermostat knob clockwise to increase or anti-clockwise to decrease.

When the appliance reaches the set temperature, the burner will go off for minimum period of approximately 3 minutes.

When the time clock or external thermostats heating request has been satisfied, the appliance will switch off automatically.

When the mode selector switch is in the hot water only or heating & hot water position, the boiler will light to supply hot water whenever a hot water outlet (tap) is opened.

Periodically the appliance will light on minimum output as a function of the pre-heat facility.

HOW TO.....

3.1 HOW TO TOP-UP THE SYSTEM PRESSURE (fig. 2)

The system pressure must be checked periodically to ensure the correct operation of the boiler. The needle on the gauge should be reading between 1 and 1.5 bar when the boiler is in an off position and has cooled to room temperature. If the pressure requires 'topping-up' use the following instructions as a guide.

- Locate the filling valve connections (below the boiler).
- Attach the filling loop to both connections.
- Open the isolating valve (Left) slowly.
- Move the filling valve (Right) slowly to the fill position (fig. 3) until you hear water entering the system.
- Move the filling valve back to its normal position (fig. 3) when the pressure gauge (on the boiler) reads between 1 and 1.5 bar.
- Close the isolating valve
- Remove the filling loop from the connections.

3.2 HOW TO RESET THE APPLIANCE

When the LED status indicator is flashing red, the appliance will require to be reset manually. Using the mode selector switch, turn it to the OFF/RESET position, then turn it back to the 'hot water only' or 'heating & hot water' position (see also 3.3).

Allow a period of two minutes to elapse before turning the mode switch to the reset position.

IMPORTANT

If the appliance requires to be reset frequently, it may be indicative of a fault, please contact your installer or Vokera Customer Services for further advice.

3.3 DIAGNOSTIC FAULT CODES

Display shows	Action required
01	Burner has failed to ignite. Ensure gas meter is turned on. Wait two minutes before resetting. If problem persists call engineer.
02	Boiler has over-heated, wait 5 minutes for boiler to cool. Reset boiler. If problem persists call engineer.
03	Flue problem. Call engineer.
04	Low water pressure. Ensure pressure gauge is above 0.5 bar (see 3.1). Reset boiler.
05	Communication fault (RC05 only). Call engineer.
06	Boiler fault. Call engineer.
07	Boiler fault. Call engineer.
08	Burner over-heat. Call engineer.
d1 & d2	Problem with condense trap/pipe/sensor. Call engineer.

3.4 HOW TO SHUT DOWN THE SYSTEM FOR SHORT PERIODS

The system and boiler can be shut down for short periods by simply turning the time clock or boiler control to the off position (see the instructions supplied). It is also advisable to turn off the main water supply to the house.

3.5 HOW TO SHUT DOWN THE SYSTEM FOR LONG PERIODS

If the house is to be left unoccupied for any length of time – especially during the winter – the system should be thoroughly drained of all water. The gas, water, and electricity supply to the house should also be turned off. For more detailed advice contact your installer.

3.6 HOW TO CARE FOR THE APPLIANCE

To clean the outer casing use only a clean damp cloth. Do not use any scourers or abrasive cleaners.

WHAT IF...

4.1 WHAT IF I SUSPECT A GAS LEAK

If you suspect a gas leak, turn off the gas supply at the gas meter, and contact your installer or local gas supplier. If you require further advice please contact your nearest Vokera office.

4.2 WHAT IF I HAVE TO FREQUENTLY TOP-UP THE SYSTEM

If the system regularly requires topping-up, it may be indicative of a leak. Please contact your installer and ask him to inspect the system.

4.3 WHAT IF THE STATUS LED IS FLASHING RED

If the red LED is flashing it indicates that the boiler or system has developed a problem, when this happens the boiler automatically shuts down and requires to be reset manually (see 3.2).

4.4 WHAT IF THE APPLIANCE IS DUE ITS ANNUAL SERVICE**Advice for tenants only**

Your landlord should arrange for servicing.

Advice for homeowners

Please contact Vokera Customer Services (**0870 333 0220 (UK) or 05655057 (ROI)**) if you would prefer a Vokera service engineer or agent to service your appliance. Alternatively your local CORGI registered engineer may be able to service the appliance for you.

4.5 WHAT IF I NEED TO CALL AN ENGINEER

If you think your boiler may have developed a fault please contact your installer or Vokera Customer Services (**0870 333 0220 (UK) or 05655057 (ROI)**) have all your details to hand including full address and postcode, relevant contact numbers, and your completed appliance log book.

VOKERA RC05 REMOTE CONTROL

INTRODUCTION



The Vokera RC05 remote control is an optional accessory that enables the boiler and its functions to be controlled from another location from that of the boiler. The RC05 can be used a room thermostat or programmable room thermostat and can also be connected to an outside temperature sensor.







When the RC05 is connected to the boiler the controls on the boiler are over-ridden by the RC05.

These instructions should be read in conjunction with the RC05 instructions if your installer has connected an RC05 remote control to your boiler.

QUICK-REFERENCE GUIDE

Boiler switched off – **OFF** is shown in the display

Hot Water only – press  until the  symbol is shown in the display. To adjust the hot water outlet temperature, press  then press the **+** or **-** buttons until the required temperature is displayed, press **ENTER** to store the new setting.

Heating & Hot Water – press  until both the  &  symbols are shown in the display. To adjust the hot water outlet temperature and/or Heating outlet temperature, press  until the required symbol is flashing  or  then press the **+** or **-** buttons until the required temperature is displayed, press **ENTER** to store the new setting.

Adjusting the room temperature setting – with the control set to the Heating & Hot Water mode, press **ENTER** the currently set room temperature will begin to flash. Use the **+** or **-** buttons until the required temperature is displayed, press **ENTER** to store the new setting.







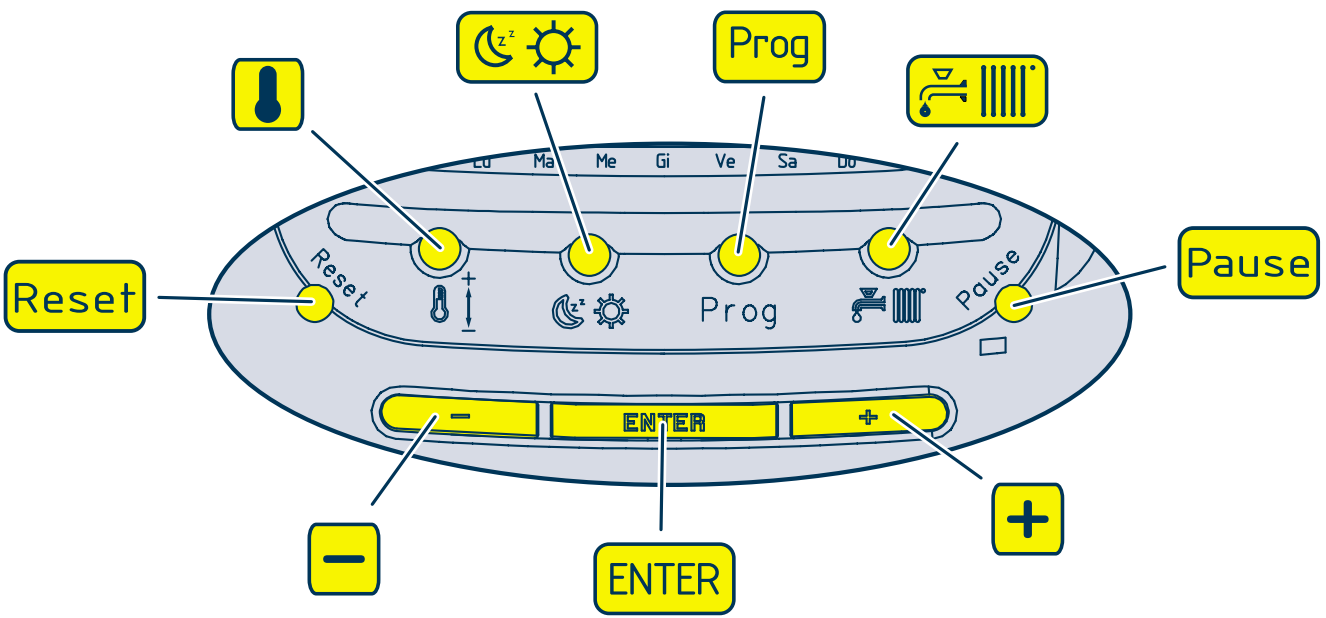

FAULT CONDITION- the  symbol and a fault code will appear in the display. Press **RESET** to enable the appliance to reset itself. Should an alarm code be repeatedly displayed, consult the users guide for specific help. **Always allow at least 2-minutes before resetting the appliance.**

VOKERA RC05 REMOTE CONTROL

DESCRIPTION OF CONTROL PANEL

DESCRIPTION OF BUTTONS



-  Regulates the heating and domestic hot water temperature
-  Makes a temporary change in level
-  Programs the boiler
-  Changes mode (OFF-SUMMER-WINTER)
-  Sets cleaning and holiday function
-  Increases setting
-  Selects and confirms data and changes room temperature
-  Decreases setting
-  Releases boiler, reset data and tests display

VOKERA RC05 REMOTE CONTROL

DESCRIPTION OF DISPLAY

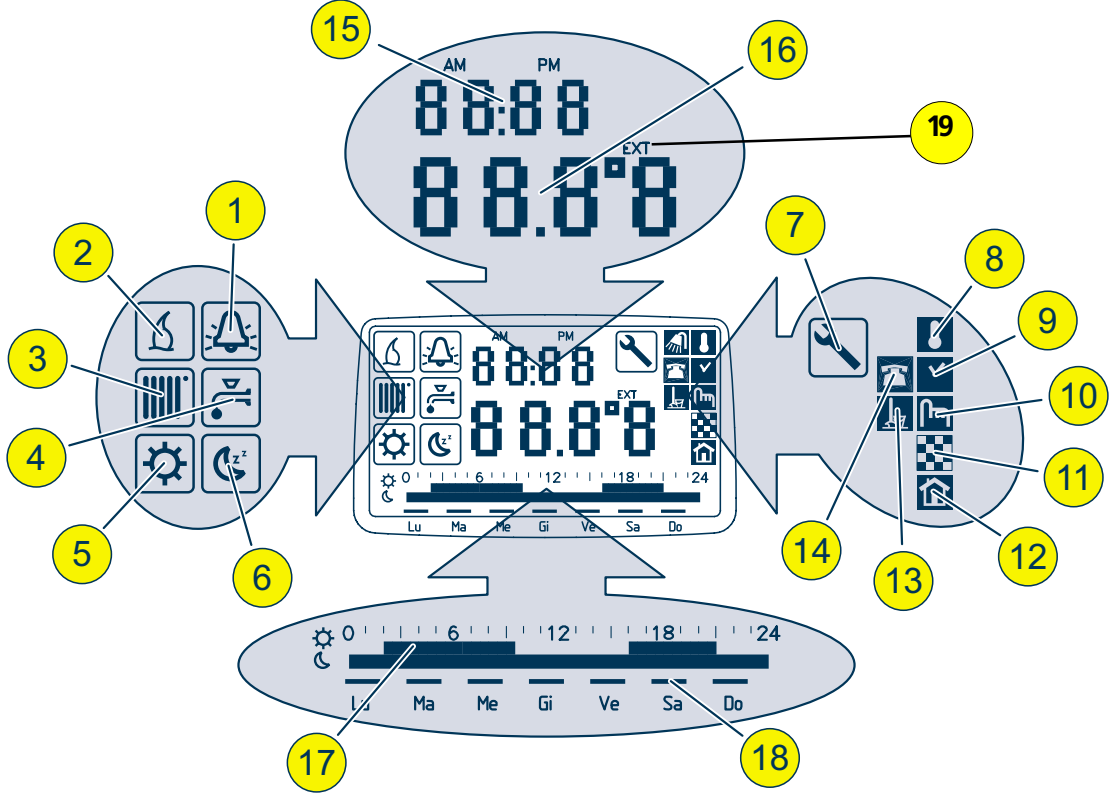

- 1 - Boiler lockout indicator
- 2 - Heat request indicator
- 3 - Heating indicator
- 4 - Domestic hot water indicator
- 5 - Economy level temperature indicator
- 6 - Comfort level temperature indicator
- 7 - Scheduled servicing indicator
- 8 - Room thermostat indicator
- 9 - Timer thermostat indicator

- 10 - Boiler control indicator
- 11 - Underfloor heating function indicator
- 12 - Thermoregulation status indicator
- 13 - Cleaning/holiday function indicator
- 14 - Telephone interface function indicator
- 15 - Time and error numeric display field
- 16 - Temperature numeric display field
- 17 - Daily schedule progress bar
- 18 - Week day display segments
- 19 - EXT, outdoor temperature

VOKERA TIME CLOCK

5.1 SETTING THE MECHANICAL CLOCK

The Vokera mechanical time clock can automatically switch your boiler on and off at the same time every day of the week. The minimum 'on' or 'off' period can be as little as 15 minutes.

The outer clock face consists of 96 black pins. Each pin represents a time period of fifteen minutes. When a pin is pushed towards the outside of the clock face, the time clock is in an 'on' position, consequently when it is pushed towards the inner part of the clock face it is in an 'off' position.

5.1.1 SETTING THE 'ON' & 'OFF' TIMES

Push the necessary amount of pins towards the outer clock face for the time period that you want the boiler to be 'on' (for example if you wanted the boiler to be on between 4.00PM and 8.00PM, push out the 16 pins located between 16 and 20 on the clock face).

5.1.2 SETTING THE 'TIME OF DAY'

Grasp the outer clock face and turn clock-wise until the correct 'time of day' is opposite the black pointer.

5.1.3 SELECTOR SWITCH

The time clock has a three-position switch. This switch over-rides the timed settings ('on' & 'off' times) of the clock.

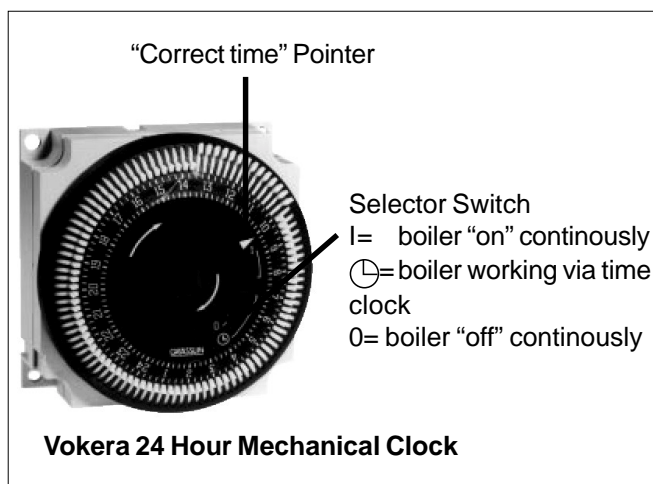

5.2 SETTING THE DIGITAL CLOCK

The Vokera digital time clock will automatically switch your boiler on and off. It has a total of twenty different switching commands, consisting of ten 'on' commands and ten 'off' commands.

Each 'on' or 'off' command can be used to switch the boiler 'on' or 'off' at the same time:

- every day of the week
- monday to Saturday
- monday to Friday
- saturday and Sunday
- any particular day.

Example

Group of days	On	Off	Commands used
Mon. to Fri.	06.00	09.00	2
Mon. to Fri.	16.00	21.00	2
Sat. & Sun.	08.30	10.30	2
Sat. & Sun.	17.00	23.00	2
		Total	8 used
Commands 'free'			12 unused

5.2.1 BEFORE PROGRAMMING

Gently press and release the 'Res.' button with a pencil or similar, this will clear the memory of all information. This should only be done when you want to change or insert a complete new programme.



5.2.2 SETTING THE TIME OF DAY

The 'real time' clock has to be set to the actual day of the week and time of day, to do this:

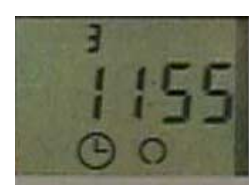
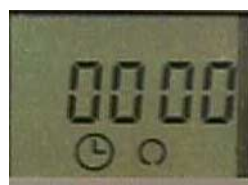
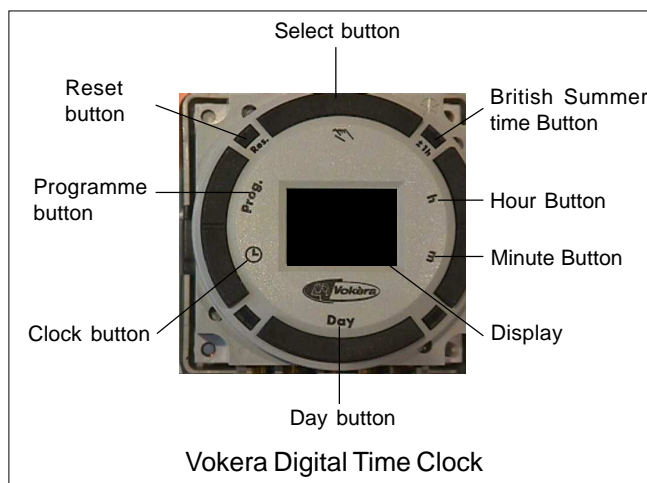
- press and hold the ⊕ button (see fig 2)
- press the 'Day' button until the actual day shows in the display (1= Monday, 2= Tuesday, 3= Wednesday, etc.)
- if setting the clock during 'British summertime' press the '+/-1h' button once (use a pencil or similar)
- press the 'h' button until the actual hour is shown in the display
- press the 'm' button until the actual minutes are showing in the display
- now release the ⊕ button
- the ':' symbol between the hours and minutes display will start to flash, this indicates that the clock is now keeping time (see fig. 3).



5.2.3 ENTERING (on) COMMANDS

- Repeatedly press the Prog. Button until the — :— symbol appears in the clock display (see fig. 4).
- Press the Day button until the desired group of days or desired day is shown.
- Press the 'h' button until the desired hour for switching the boiler on is shown.
- Press the 'm' button until the desired minutes are shown.
- Press the Select button until the  symbol is shown (see fig. 5).
- Press the  button.

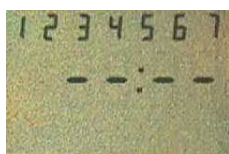



Fig. 4



Fig. 5

5.2.4 ENTERING (off) COMMANDS

- Repeatedly press the Prog. Button until the — :— symbol appears in the clock display (fig. 4).
- Press the Day button until the desired group of days or desired day is shown.
- Press the 'h' button until the desired hour for switching the boiler off is shown.
- Press the 'm' button until the desired minutes are shown.
- Press the Select button until the  symbol is shown (see fig. 6).
- Press the  button.

HELPFUL HINTS

- You can check and/or alter the programme settings at any time by pressing the Prog button.
- The number of unused 'commands' can be checked by pressing the Prog button until FR is displayed alongside the number of unused commands.
- In the event of a power failure, the clock has a battery back-up. The programme will be held in the memory for approximately 2 weeks. Charging time is 70 hours.
- Take a note of the settings you have programmed, as local power surges can sometimes reset the memory of the clock.

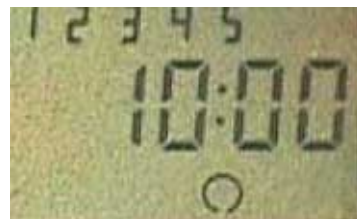







Fig. 6

Once the programming has been completed you will have to press the Select button – once only – to the  (on) position if the boiler has been programmed to be 'on' at that particular time.

5.2.5 ADVANCING OR LOCKING PROGRAMME COMMANDS

By pressing the Select button you can advance the time clock to the next command setting (from 'on' to 'off' or 'off' to 'on') or lock the time clock to a particular command ('on' continuously or 'off' continuously).

-  - ON
-  - OFF
- [] - ON CONTINUOUSLY
- [] - OFF CONTINUOUSLY

NOTE

The actual time can be changed to account for British summertime by simply pressing then releasing the +/- 1h button.



energizing home heating

Vokèra Ltd.

4th Floor, Catherine House, Boundary Way, Hemel Hempstead, Herts, HP2 7RP

Email: enquiries@vokera.co.uk Web: www.vokera.co.uk

Sales, Technical Advice, General Enquiries - Tel: 0870 333 0520 Fax: 01442 281403

After Sales Service - Tel: 0870 333 0220

Vokèra Ireland

West Court, Callan, Co Kilkenny

Tel: 05677 55057 Fax: 05677 55060

Vokèra Ltd. reserve the right to change the specifications without prior notice. Consumers' statutory rights are not affected.

A Riello Group Company



"Vokèra"
supports Benchmark