

THIS DOCUMENT HAS BEEN PROVIDED BY



heatingspares
247.com

PLEASE VISIT WWW.HEATINGSPPARES247.COM FOR FURTHER
INFORMATION AND GENUINE PARTS & SPARES AT LOW PRICES

Vokèra
heating for life

Mynute VHE

High efficiency open vent boiler

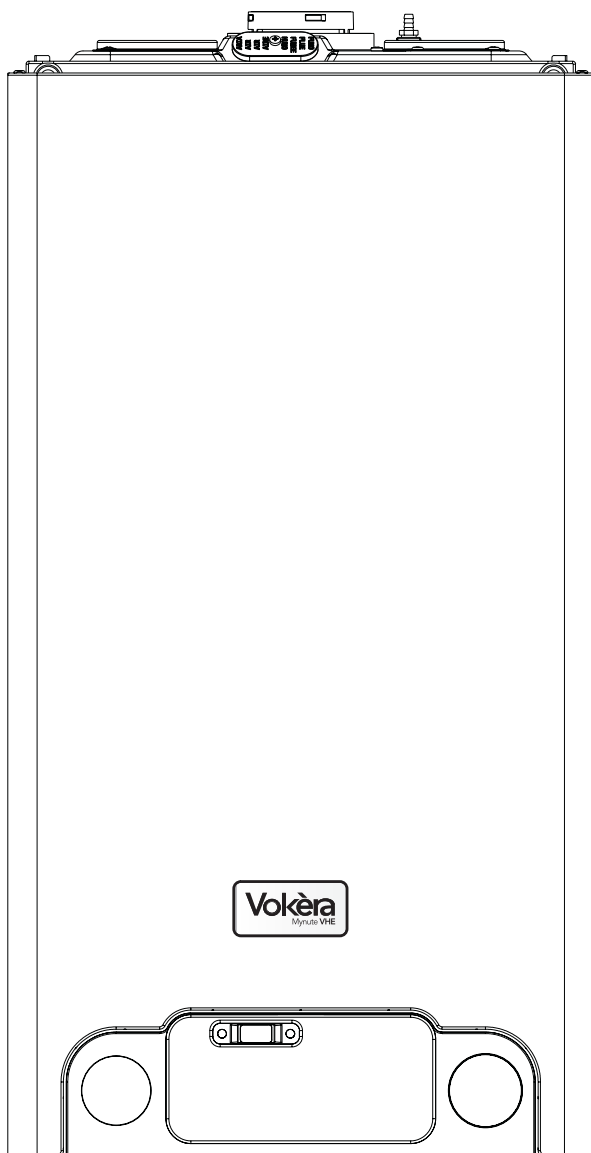

Users Instructions



THESE INSTRUCTIONS
TO BE RETAINED
BY USER



Vokèra is a licensed member of the Benchmark scheme which aims to improve the standards of installation and commissioning of domestic hot water systems in the UK.

Contents

| Introduction | Page |
|------------------|------|
| Dear customer | 2 |
| Do's and don't's | 2 |

| Things you should know | Page |
|----------------------------------|------|
| 1.1 Gas appliances | 3 |
| 1.2 Electrical supply | 3 |
| 1.3 Guarantee registration card | 3 |
| 1.4 Appliance log book (UK only) | 3 |
| 1.5 How does it work? | 3 |
| 1.6 Dimensions | 3 |
| 1.7 Clearances | 3 |
| 1.8 Frost protection | 3 |
| 1.9 Status indicators | 3 |
| 1.10 Digital display | 4 |

| Getting started | Page |
|---|------|
| 2.1 Before switching on | 5 |
| 2.2 Appliance controls | 5 |
| 2.3 Lighting the boiler | 5 |
| 2.4 Adjusting the operating temperature | 5 |

| How to... | Page |
|--|------|
| 3.2 Reset the appliance | 6 |
| 3.3 Shut down the system for short periods | 6 |
| 3.4 Shut down the system for long periods | 6 |
| 3.5 Care for the appliance | 6 |

| What if... | Page |
|---|------|
| 4.1 I suspect a gas leak | 7 |
| 4.2 The RED fault light is on | 7 |
| 4.3 The appliance is due its annual service | 7 |
| 4.4 I need to call an engineer | 7 |
| 4.5 The display shows an unusual code or number | 7 |

INTRODUCTION

Dear Customer

Your Vokera Mynute VHE boiler has been designed to meet and exceed the very latest standards in gas central heating technology, and if cared for, will give years of reliable use and efficiency.

Please therefore take some time to read these instructions carefully.

Do's and Don't's

- **Do** ensure that you know how to isolate the appliance in an emergency
- **Do** ensure that you are familiar with the appliance controls
- **Do** ensure that your installer has completed the appliance log book section
- **Do not** attempt to remove the appliance casing or gain internal access
- **Do not** hang clothes etc. over the appliance
- **Do not** forget to have the appliance serviced annually.

This booklet is an integral part of the appliance. It is therefore necessary to ensure that the booklet is handed to the person responsible for the property in which the appliance is located/installed. A replacement copy can be obtained from Vokera customer services.

THINGS YOU SHOULD KNOW

1.1 GAS APPLIANCES

Gas Safety (Installations and Use) Regulations (UK).

In the interests of your safety and that of others it is a legal requirement that all gas appliances are installed and correctly maintained by a competent person and in accordance with the latest regulations.

1.2 ELECTRICAL SUPPLY

Please ensure that this appliance has been properly connected to the electrical supply by means of a double pole isolator or un-switched socket, and that the correct size of fuse (3 AMP) has been fitted.

Warning: this appliance must be earthed!

1.3 GUARANTEE REGISTRATION CARD

Please take the time to fill out your guarantee registration card. The completed warranty card should be posted within 30 days of installation.

1.4 APPLIANCE LOG BOOK (UK only)

A logbook section can be found at the rear of the appliance installation booklet. This important document must be completed during the installation/commissioning of your boiler. All CORGI registered installers carry a CORGI ID card, and have a registration number. These details should be recorded in the Benchmark logbook section within the installation booklet. You can check your installers details by calling CORGI direct on 01256 372300. Failure to install and commission the appliance in accordance with the manufacturers instructions may invalidate the warranty. This does not affect your statutory rights.

1.5 HOW DOES IT WORK?

Your Mynute VHE boiler supplies heated water to your radiators and hot water tank.

The central heating and hot water is controlled via a time clock or programmer and any thermostats that your installer may have fitted. The boiler will light when it receives a request from the time clock or programmer via any thermostat that may also be installed. Your Mynute HE boiler lights electronically and does not have a pilot light. In the unlikely event of a fault developing with your boiler, the supply of gas to the burner will be terminated automatically.

1.6 DIMENSIONS

| | | |
|--------------|--------|-------|
| Mynute 20VHE | HEIGHT | 740mm |
| | WIDTH | 400mm |
| | DEPTH | 340mm |

1.7 CLEARANCES REQUIRED

| | |
|------------|--------|
| ABOVE | 150 mm |
| BELOW | 150 mm |
| LEFT SIDE | 50 mm |
| RIGHT SIDE | 12mm |
| FRONT | 600 mm |

1.8 FROST PROTECTION SYSTEM

The Mynute VHE is equipped with a built-in frost protection system, this enables the boiler to over-ride the time controls – even if switched off – and operate the burner and/or pump, should the temperature drop below 5 °C.

Please note that the frost protection system is designed to protect the appliance only, should frost protection be required for the heating system, additional controls may be required.

When the frost protection system has been activated, 'AF' is displayed on the appliance LED display (see below).

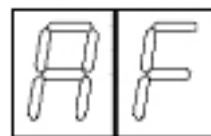

NOTE

The frost protection system is reliant on the appliance having a permanent electrical supply, and being in a non-fault condition.

1.9 APPLIANCE STATUS INDICATORS

Your boiler is equipped with 2 status LED indicators, the Green LED indicates that the appliance is working normally, whilst the Red LED indicates the appliance has detected a fault.

1.10 DIGITAL DISPLAY

The 2-digit digital display will normally show the current working (outlet) temperature of the boiler, however in certain circumstances a fault code or specific characters will be displayed to indicate that the appliance is performing a specific function.

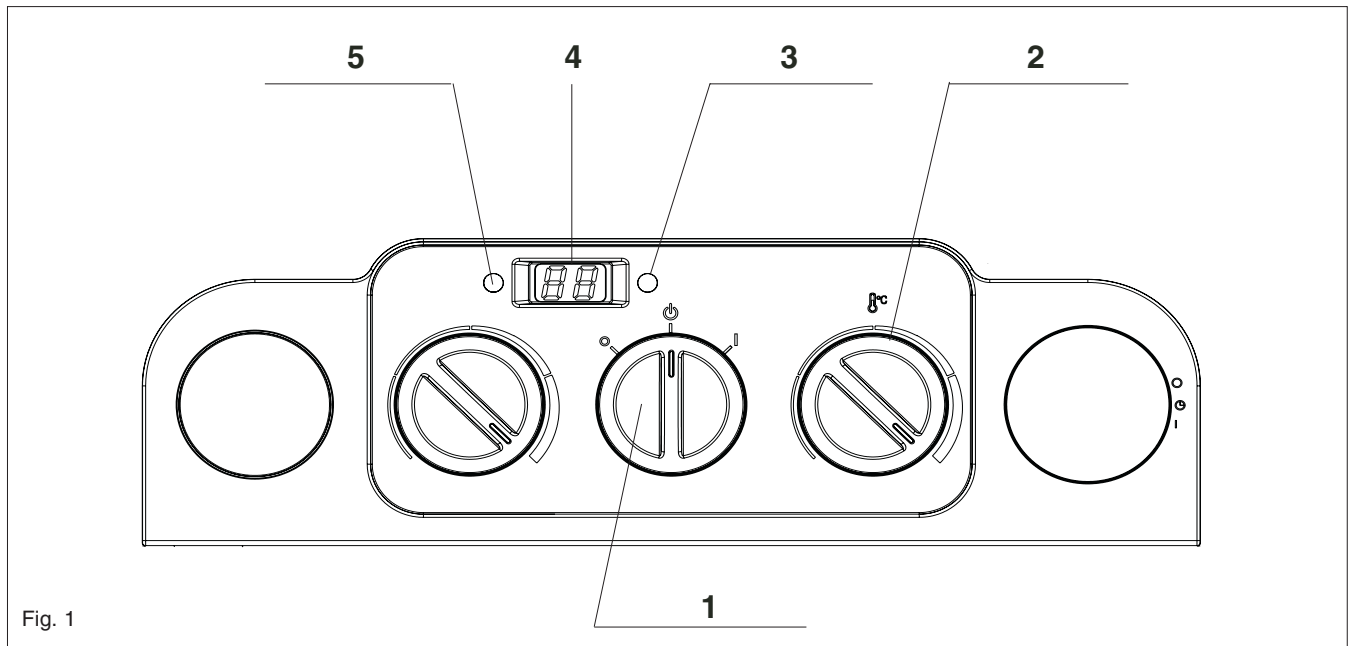
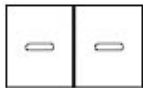

Fig. 1

1. Mode selector switch
2. Temperature selector
3. Red LED indicator
4. 2-digit display
5. Green LED indicator

The 2-digit display can show several different modes of operation:



OFF mode

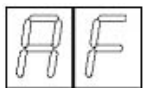

Frost protection mode active

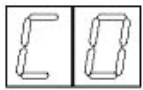

Combustion analysis mode active



Autostop function active

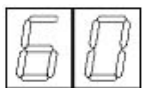

Normal heating request (example 60°C).

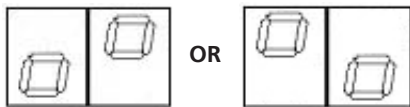

Purge cycle mode.

GETTING STARTED

2.1 BEFORE SWITCHING ON

Before switching the appliance on please familiarise yourself with:

- how to isolate the appliance from the gas and electricity supplies;
- the time clock or programmer (if fitted);
- any external thermostats and their functions;
- the appliance controls.

2.2 APPLIANCE CONTROLS (see fig. 1)

The appliance controls are situated on the lower front of the appliance. The appliance controls include:

- appliance mode selector;
- temperature selector;
- 2-digit LED display;
- status indicator (green);
- fault indicator (red).

The **appliance mode selector** is used to switch the boiler to the various operating modes:

- RESET “”
- OFF “”
- ON “”.

NOTE

The appliance frost protection is active in all of the above modes.

The **temperature selector** can be used to vary the temperature of the water that circulates around your radiators and/or hot water tank. The temperature range is adjustable between 40°C and 76°C.

The **2-digit LED display normally** shows the operating temperature of the appliance, however it can also display additional characters or flashing numbers to signify specific operating modes or fault codes.

When the **status indicator (Green) is lit** it indicates that the appliance is in operation.

When the **fault indicator (Red) is lit** it indicates that the appliance has identified a possible fault and performed a safety shutdown.

2.3 LIGHTING THE BOILER

Ensure the gas and electrical supply to the boiler is turned on. Turn the mode selector switch to the ON position.

When there is a request for heating or hot water via the time clock or programmer, the boiler will begin an ignition sequence. When the appliance reaches the set temperature, the burner will go off for a minimum period of approximately 5 minutes.

When the programmer/time clock or external thermostats heating request has been satisfied, the appliance will switch off automatically.

2.4 ADJUSTING THE OPERATING TEMPERATURE

Rotate the temperature selector – clockwise to increase, counter-clockwise to decrease – to the desired temperature setting. The temperature can be set from a minimum of 40°C to a maximum of 76°C.

NOTE

If the appliance fails to ignite during the ignition sequence, it will enter a lockout condition. Should this occur, please allow a period of at least two minutes before re-setting the appliance.

HOW TO...**3.1 HOW TO RESET THE APPLIANCE**

When the red fault LED is illuminated, the appliance will require to be reset manually. Before resetting the boiler, check what action is required to be taken, using the information on the fault code table below. Allow a period of two minutes to elapse before pressing the reset button.

APPLIANCE FAULT CODES

| CODE | ACTION REQUIRED |
|-------------|---|
| AL10 | Reset appliance. Call engineer if fault re-occurs |
| AL20 | Reset appliance. Call engineer if fault re-occurs |
| AL21 | Reset appliance. Call engineer if fault re-occurs |
| AL26 | Reset appliance. Call engineer if fault re-occurs |
| AL28 | Reset appliance. Call engineer if fault re-occurs |
| AL34 | Reset appliance. Call engineer if fault re-occurs |
| AL52 | Call engineer |
| AL55 | Call engineer |
| AL60 | Call engineer |
| AL71 | Reset appliance. Call engineer if fault re-occurs |
| AL73 | Reset appliance. Call engineer if fault re-occurs |
| AL74 | Reset appliance. Call engineer if fault re-occurs |
| AL79 | Reset appliance. Call engineer if fault re-occurs |

IMPORTANT

If the appliance requires to be reset frequently, it may be indicative of a fault, please contact your installer or Vokera Customer Services for further advice.

3.2 HOW TO SHUT DOWN THE SYSTEM FOR SHORT PERIODS

The system and boiler can be shut down for short periods by simply turning the time clock to the off position. It is also advisable to turn off the main water supply to the house.

3.3 HOW TO SHUT DOWN THE SYSTEM FOR LONG PERIODS

If the house is to be left unoccupied for any length of time – especially during the winter – the system should be thoroughly drained of all water. The gas, water, and electricity supply to the house should also be turned off. For more detailed advice contact your installer.

3.4 HOW TO CARE FOR THE APPLIANCE

To clean the outer casing use only a clean damp cloth. Do not use any scourers or abrasive cleaners.

WHAT IF...

4.1 WHAT IF I SUSPECT A GAS LEAK

If you suspect a gas leak, turn off the gas supply at the gas meter, and contact your installer or local gas supplier. If you require further advice please contact your nearest Vokera office.

4.2 WHAT IF THE RESET LIGHT IS ON

If the Red LED light is illuminated, it indicates that the boiler has failed to ignite or has detected a possible fault. When this happens the boiler automatically shuts down and requires to be reset manually (see 3.2).

4.3 WHAT IF THE APPLIANCE IS DUE ITS ANNUAL SERVICE

Advice for tenants only

Your landlord should arrange for servicing.

Advice for homeowners

Please contact Vokera Customer Services (**0870 333 0220 (UK) or 05655057 (ROI)**) if you would prefer a Vokera service engineer or agent to service your appliance. Alternatively your local CORGI registered engineer may be able to service the appliance for you.

4.4 WHAT IF I NEED TO CALL AN ENGINEER

If you think your boiler may have developed a fault please contact your installer or Vokera Customer Services (**0870 333 0220 (UK) or 05655057 (ROI)**) have all your details to hand including full address and postcode, relevant contact numbers, and your completed appliance log book.

4.5 WHAT IF THE DISPLAY SHOWS AN UNUSUAL CODE OR NUMBER

The boiler may show an unusual code or character to signify that a special function is in operation or that the boiler requires attention (see 3.1). Whilst some functions are automatically enabled/disabled, others require manual intervention and you may therefore need to contact you engineer or landlord.

The 2-digit display can show several different modes of operation:



OFF mode

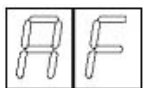

Frost protection mode active

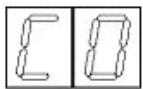

Combustion analysis mode active



Autostop function active



Normal heating request (example 60°C).

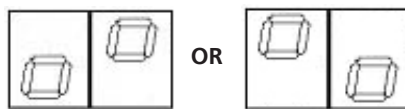

Purge cycle mode.

- The OFF mode will be displayed when the selector switch is in the OFF position.
- The frost protection mode becomes active automatically if the temperature inside the boiler drops below an acceptable level. This function will be enabled and disabled automatically and no user intervention is necessary.
- Your engineer uses the combustion analysis mode when checking and/or adjusting your boiler. This function requires to be enabled by the engineer.
- The autostop function - if enabled by your social housing provider or landlord – will be displayed to alert you that appliance is due its annual inspection. You should contact your housing provider/landlord if this function is displayed.
- The normal heating request or outlet temperature will be displayed when you adjust the temperature selector or when the boiler is in operation.

The purge cycle mode function is enabled if the electrical supply to the boiler has been switched off or interrupted. This mode will be active for 2-minutes once the electrical power has been restored to the boiler.



Cod. 10029719 - 05/07 - Ed. 1

Registered address:

Vokèra Ltd
Borderlake House
Unit 7 Riverside Industrial Estate
London Colney
Herts AL2 1HG

enquiries@vokera.co.uk

www.vokera.co.uk
www.vokera.ie

Sales, General Enquires

T 0844 391 099
F 0844 391 0998

Vokèra Ireland
West Court, Callan
Co Kilkenny
T 056 7755057
F 056 7755060

Vokèra Limited reserve the right to change
specification without prior notice
Consumers statutory rights are not affected.

A Riello Group Company.
Company Reg No: 1047779