

THIS DOCUMENT HAS BEEN PROVIDED BY



PLEASE VISIT [WWW.HEATINGSPPARES247.COM](http://WWW.HEATINGSPPARES247.COM) FOR FURTHER INFORMATION AND GENUINE PARTS & SPARES AT LOW PRICES

**Vokèra**  
heating for life

# Compact

## Standard efficiency combi boiler

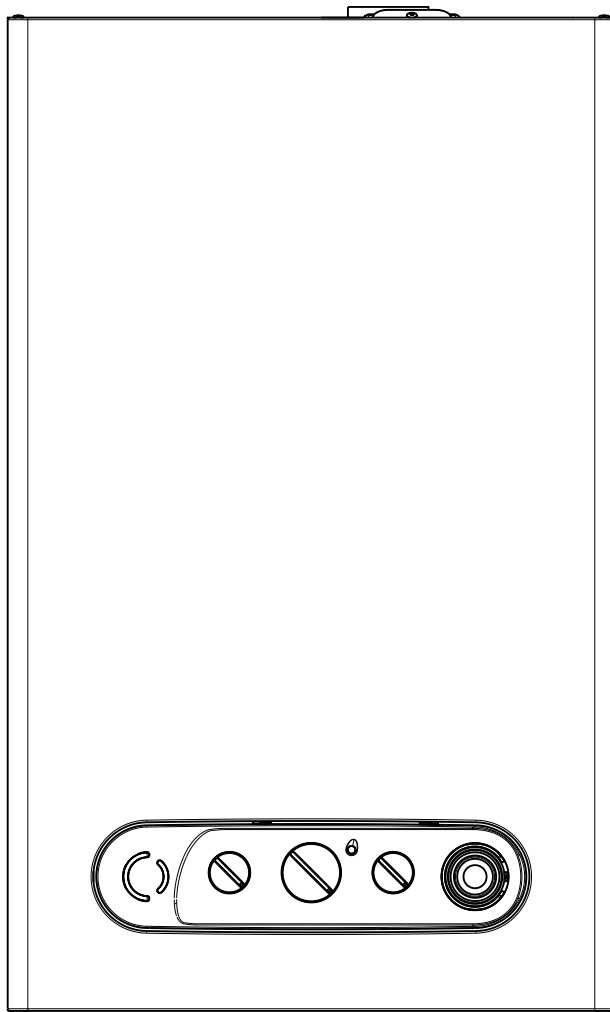

### Users Instructions

CE

THESE INSTRUCTIONS  
TO BE RETAINED  
BY USER



Vokèra is a licensed member of the Benchmark scheme which aims to improve the standards of installation and commissioning of domestic hot water systems in the UK.

## Contents

Introduction		Page
Dear customer		2
Do's and don't's		2
Things you should know		Page
1.1	Gas appliance	3
1.2	Electrical supply	3
1.3	Explanation of controls	3
1.3.1	Mode selector switch...	3
1.3.2	Hot water...	3
1.3.3	Heating and hot water...	3
1.3.4	Time clock	3
1.4	Explanation of features	3
1.4.1	Frost protection mode	3
1.4.2	Automatic heating regulation	3
1.4.3	Anti seize function	4
1.4.4	Appliance status indicators	4
1.5	Guarantee registration card	4
1.5.1	Benchmark log book	4

How to...		Page
2.1	Use the appliance for the 1 <sup>st</sup> time	4
2.2	Use the mode selector switch	4
2.2.1	Obtain hot water	4
2.2.2	Obtain central heating	4
2.3	Re-pressuring the system	4
2.4	Shut down the system for short periods	4
2.5	Shut down the system for long periods	4
2.6	Care for the appliance	4

What if...		Page
3.1	I suspect a gas leak	5
3.2	I frequently have to top-up the system	5
3.3	The fault light is on	5
3.4	The appliance is due its annual service	5
3.5	I need to call an engineer	5
3.6	I want to extend the warranty	5

## INTRODUCTION

### Dear Customer

Your Vokera Compact boiler has been designed to meet and exceed the very latest standards in gas central heating technology and if cared for, will give years of reliable use and efficiency.

Your Vokera Compact is a combination boiler supplying central heating and instantaneous domestic hot water. Features included are an integral time clock, LED indicators showing the status of the appliance and system pressure, 2-stage frost protection and anti-pump seize function.

Please therefore take some time to read these instructions carefully.

### Do's and don't's

- **Do** ensure that the system pressure is periodically checked
- **Do** ensure that you know how to isolate the appliance in an emergency
- **Do** ensure that you are familiar with the appliance controls
- **Do** ensure that your installer has completed the appliance log book
- **Do not** attempt to remove the appliance casing or gain internal access
- **Do not** hang clothes etc. over the appliance
- **Do not** operate on sealed components
- **Do not** forget to have the appliance serviced annually.

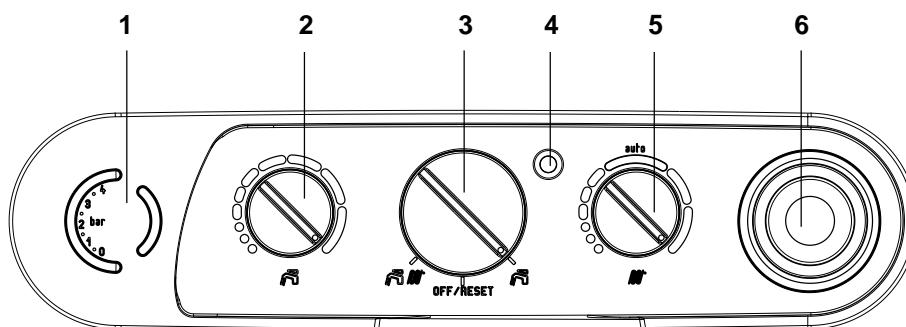

- 1= Pressure gauge
- 2= DHW position
- 3= Mode selector switch
- 4= Fault indicator led
- 5= CH position
- 6= Timeclock

Fig. 1

## THINGS YOU SHOULD KNOW

### 1.1 GAS APPLIANCE

#### Gas safety (Installation and Use) regulations

In the interests of your safety and that of others, it is a legal requirement that all gas appliances are installed and correctly maintained by a competent person and in accordance with the latest regulations.

### 1.2 ELECTRICAL SUPPLY

Please ensure that this appliance has been properly connected to the electrical supply by means of a double pole isolator or un-switched socket and that the correct size of fuse – 3 amp – has been fitted.

**Warning: this appliance must be earthed!**

### 1.3 EXPLANATION OF CONTROLS

The Vokera Compact has been designed for simplicity of use, as a result there are only two controls – the mode selector switch & the time clock – that can be accessed by the user.

#### 1.3.1 MODE SELECTOR SWITCH AT:

**OFF:** when the mode selector switch is in the 'OFF' position, the appliance will not function for hot water or heating. However the appliance will still operate in frost protection mode, and if unused for a period of 24 hours, will momentarily activate the pump to prevent seizure due to non-use.

#### NOTE

The appliance must have an electrical supply at all times for the frost protection and anti-seize modes to operate.

**1.3.2 HOT WATER ONLY** “”: when the mode selector switch is in the 'HOT WATER ONLY' position, the appliance will operate as above. However when a hot water outlet is opened the appliance will operate to provide hot water until the demand for hot water has been satisfied.

#### NOTE

The appliance delivers a fixed maximum flow rate of hot water, therefore if a hot water outlet is

turned on full, it is most likely that you will be unable to obtain hot water from another outlet at the same time.

**1.3.3 HEATING AND HOT WATER** “”: when the mode selector switch is in the 'HEATING AND HOT WATER' position the appliance will operate as above. However should the time clock be switched on automatically or manually, the appliance will operate to provide heat to the central heating circuit until the demand has been satisfied.

#### NOTE

If a room thermostat is fitted it must be calling for heat before the appliance will operate.

#### 1.3.4 TIME CLOCK

The Vokera Compact is supplied with a built-in, 24-hour, time clock that can be set to operate the appliance for central heating. However it may be that your installer has fitted an external time clock (usually because of the location of the appliance i.e. loft, basement, outhouse, etc.) if so, please disregard the following instructions and refer to those supplied with the external time clock.

### 1.4 EXPLANATION OF FEATURES

Although the Vokera Compact has been designed for simplicity of use, it utilises the latest in boiler technology, enabling a host of functions to be carried out simultaneously.

#### 1.4.1 FROST PROTECTION MODE

Should the temperature of the appliance fall to 7 °C. the pump will be activated for a period of 15 minutes or until the temperature of the appliance rises to 10 °C. This will be repeated every two hours. Should the temperature of the appliance fall to 5 °C. the burner will ignite until the appliance temperature rises to 30 °C.

#### 1.4.2 AUTOMATIC HEATING REGULATION

The boiler will automatically adjust its output temperature to suit site conditions. However,

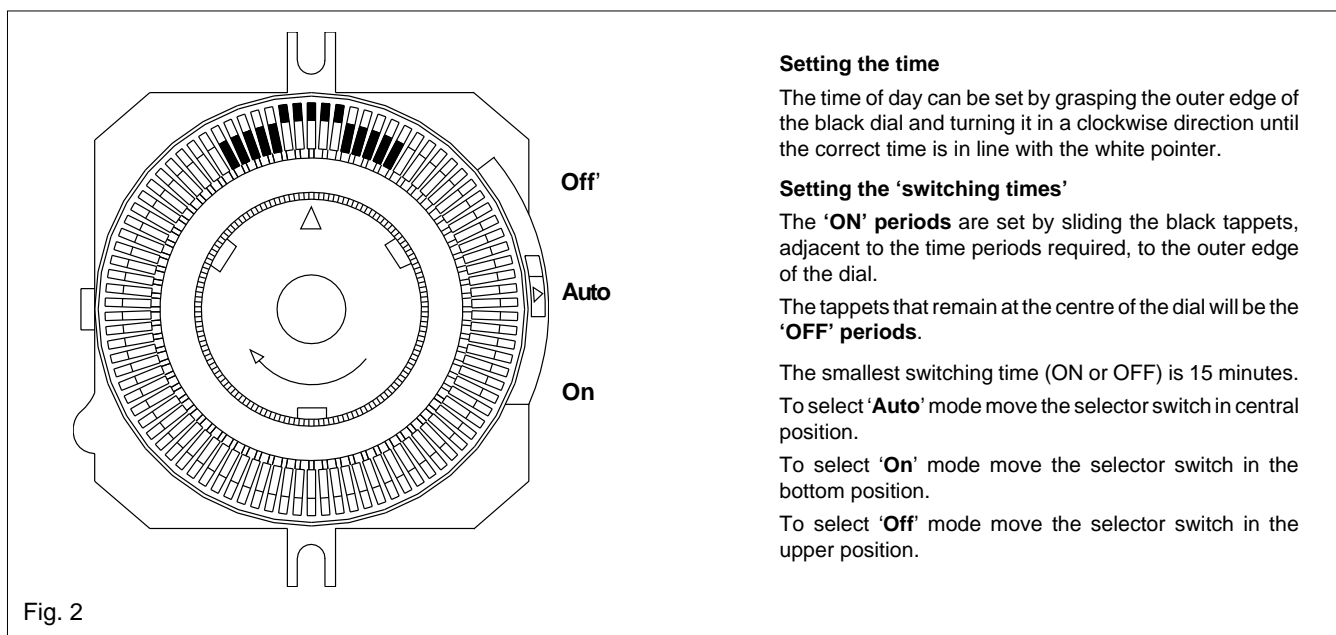

Fig. 2

#### Setting the time

The time of day can be set by grasping the outer edge of the black dial and turning it in a clockwise direction until the correct time is in line with the white pointer.

#### Setting the 'switching times'

The 'ON' periods are set by sliding the black tappets, adjacent to the time periods required, to the outer edge of the dial.

The tappets that remain at the centre of the dial will be the 'OFF' periods.

The smallest switching time (ON or OFF) is 15 minutes. To select 'Auto' mode move the selector switch in central position.

To select 'On' mode move the selector switch in the bottom position.

To select 'Off' mode move the selector switch in the upper position.

your installer may have adjusted this setting during commissioning.

Please refer to the installation instructions for full details.

**1.4.3 ANTI-SEIZE FUNCTION**

Should the appliance remain inactive for a period of 24 hours, the pump will be activated for a few seconds to prevent seizure.

**1.4.4 APPLIANCE STATUS INDICATORS**

The Vokera Compact has status indicators that show if the appliance is working normally, if it needs 'topping up' or re-pressurising, or if it has a fault (see below).

**1.5 GUARANTEE REGISTRATION CARD**

Please take the time to fill out your guarantee

registration card. The completed warranty card should be posted within 30 days of installation.

**1.5.1 BENCHMARK LOG BOOK**

The **Benchmark** Log Book is supplied with your boiler. This important document must be completed during the installation/commissioning of your boiler. All CORGI Registered Installers carry a CORGI ID card, and have a registration number.

Both should be recorded in your **Benchmark** Log Book. You can check your installer by calling CORGI direct on 01256 372300.

Failure to install and commission the appliance in accordance with the manufacturers instructions may invalidate the warranty. This does not affect your statutory rights .

**HOW TO...**

**2.1 USE THE APPLIANCE FOR THE FIRST TIME**

Before switching the appliance on please familiarise yourself on how to isolate the appliance from the electricity, gas, and water supplies. If in doubt contact your installer.

**2.2 USE THE MODE SELECTOR SWITCH**

Turn the mode selector switch to the OFF position, switch on the electrical supply to the appliance. The green LED should be illuminated, you may now select either HOT WATER ONLY or HEATING AND HOT WATER.

**2.2.1 OBTAIN HOT WATER**

By turning on a hot water outlet (tap) the boiler will fire to deliver hot water.

The appliance will have been commissioned by your installer to deliver hot water at both a reasonable temperature and flow rate, should you wish to increase the temperature of the hot water simply reduce the flow of water as it comes out of the tap. Please consult your installer for further advice if required.

**2.2.2 OBTAIN CENTRAL HEATING**

When the time clock is in an 'on' position, and the room thermostat – if fitted – is calling for heat, the boiler will fire to provide central heating.

**2.3 RE-PRESSURING THE SYSTEM**

The system will need re-pressurising if the red LED is illuminated. Locate the filling valve and if necessary connect the loop (fig. 3) slowly open the valve until you hear the water entering the appliance. The red LED will go out first. Go on with re-pressuring until the pressure shown on the manometer is between 1 & 1.5 bar (fig. 4). The appliance must not be operated until the system has been re-pressurised. If in doubt contact your installer.

**2.4 SHUT DOWN THE SYSTEM FOR SHORT PERIODS**

The system can be shut down for short periods by simply turning the mode selector to the OFF position. It is also advisable to turn off the main water supply to the house.

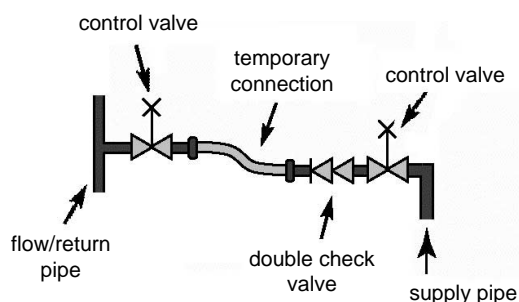

Fig. 3

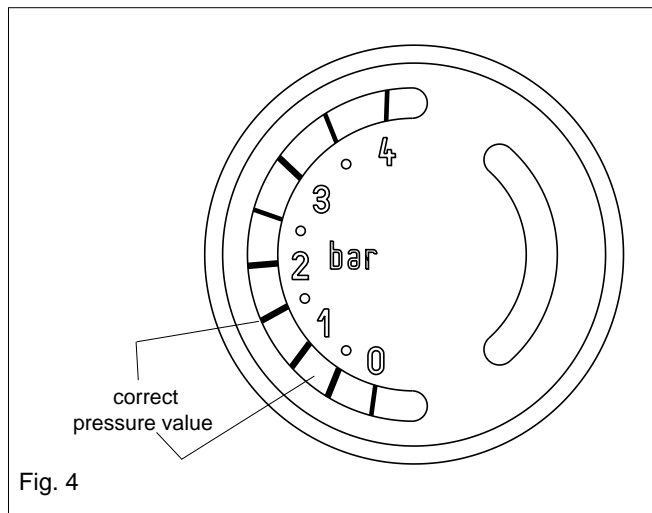

Fig. 4

**2.5 SHUT DOWN THE SYSTEM FOR LONG PERIODS**

If the house is to be left unoccupied for any length of time – especially during the winter - the system should be thoroughly drained of all water. The gas should be turned off at the meter and the main water supply should be turned off at the stopcock. If necessary contact your installer for further advice.

**2.6 CARE FOR THE APPLIANCE**

To clean the outer casing use only a clean damp cloth. Do not use any scourers or abrasive cleaners.

**STATUS INDICATORS**

Green LED	Red LED	Reason	Action required
On/flashing	Off	Appliance is ok	None
On	Off	Low/zero pressure	Requires 'topping-up' See page 4
Off	On	Internal fault	Reset, see page 5
Off	Off	No power, blown fuse, Internal fault	Ensure power supply to Boiler is on, check fuse, Contact engineer

**WHAT IF...**

**3.1 I SUSPECT A GAS LEAK**

If you suspect a gas leak, turn off the gas supply at the gas meter, and contact your installer or local gas supplier. If you require further advice please contact your nearest Vokera office.

**3.2 I FREQUENTLY 'TOP-UP' OR 'RE-PRESSURISE' THE SYSTEM**

If the system regularly requires topping-up or re-pressurising, it may be indicative of a leak. Please contact your installer and ask him to inspect the system.

**3.3 THE FAULT LIGHT IS ON**

If the red LED is illuminated it indicates that the appliance has 'locked-out' or has an internal fault. To reset the appliance, make sure the gas supply is on to the appliance. Turn the mode selector switch to the OFF position for a few seconds and then turn it back to its previous position. If the red LED stays on or is illuminated after a few seconds call an engineer.

**NOTE**

If both the red and yellow LED's are illuminated, the system requires to be re-pressurised (see page 4).

**3.4 THE APPLIANCE IS DUE ITS ANNUAL SERVICE**

Please contact Vokera Customer Services (**0870 333 0220 U.K. or 05655057 R.O.I.**) if you would prefer a Vokera service engineer or agent to service your appliance. Alternatively your local CORGI registered engineer may be able to service the appliance for you. If you are a tenant your landlord will arrange for servicing.

**3.5 I NEED TO CALL AN ENGINEER**

If you think your boiler may have developed a fault, please contact your installer or Vokera customer services.

**(0870 333 0220 U.K. or 05655057 R.O.I.)** Have all your details to hand including full address and postcode, relevant contact numbers, and your appliance logbook.

**3.6 I WANT TO EXTEND THE WARRANTY**

Vokera offer extended warranties on all current Vokera appliances, simply contact customer services (**0870 333 0220 U.K. or 05655057 R.O.I.**) for further information.

**MINIMUM CLEARANCES**

Please observe the following minimum clearances required for the safe operation and maintenance of this appliance

Above the appliance	150mm	6 inches
Below the appliance	150mm	6 inches
Left hand side of appliance	50mm	2 inches
Right hand side of appliance	12mm	_ inches
In front of appliance	600mm	24 inches







**Registered address:**

Vokèra Ltd  
Borderlake House  
Unit 7 Riverside Industrial Estate  
London Colney  
Herts AL2 1HG

**enquiries@vokera.co.uk**

**www.vokera.co.uk**  
**www.vokera.ie**

**Sales, General Enquires**

**T 0844 391 099**  
**F 0844 391 0998**

Vokèra Ireland  
West Court, Callan  
Co Kilkenny  
**T 056 7755057**  
**F 056 7755060**

Vokèra Limited reserve the right to change  
specification without prior notice.  
Consumers statutory rights are not affected.

A Riello Group Company.  
Company Reg No: 1047779