

User Guide and Important Warranty Information

Promax Combi HE Plus LPG

Condensing
Combination Boiler

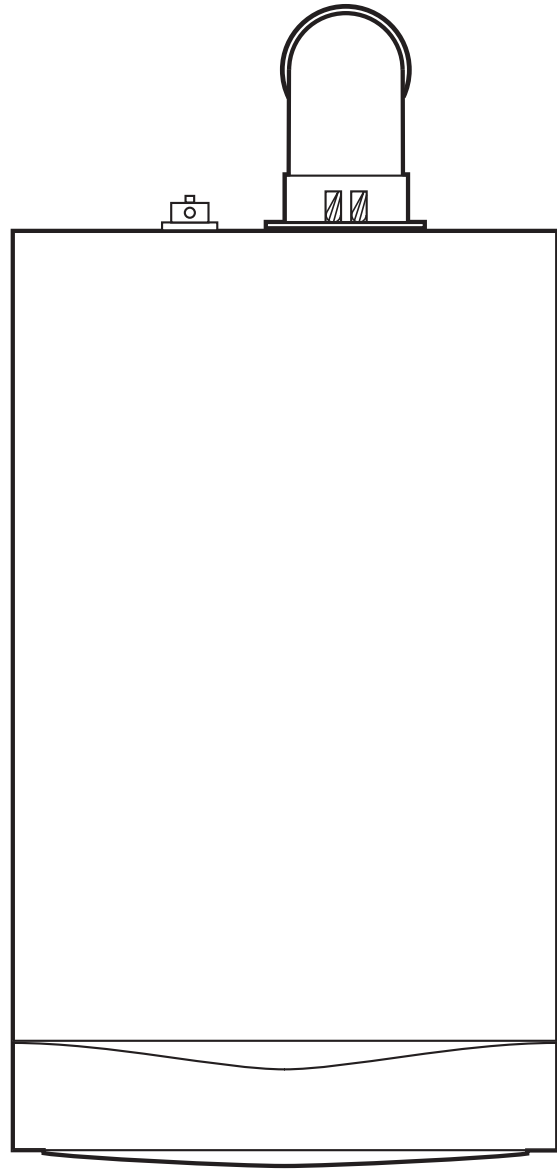

THIS DOCUMENT HAS BEEN PROVIDED BY
heatingspares247.com
PLEASE VISIT WWW.HEATINGSPPARES247.COM FOR FURTHER
INFORMATION AND GENUINE PARTS & SPARES AT LOW PRICES



Please keep these instructions in a safe place.
If you move house, please hand them over to
the next occupier.

Contents

Propane

Potterton Promax Combi 24 HE Plus LPG
G.C.N° 47 393 24

Section	Page
1.0 Quick Reference Guide	3
2.0 Troubleshooting	4
3.0 Repressurising System	6
4.0 Clearances	7
5.0 Care of the Boiler	8
6.0 Legislation	9
7.0 Notes	10
8.0 Emergency	11
9.0 Warranty & Service	12

Where fitted, user label for optional timer to be applied here.

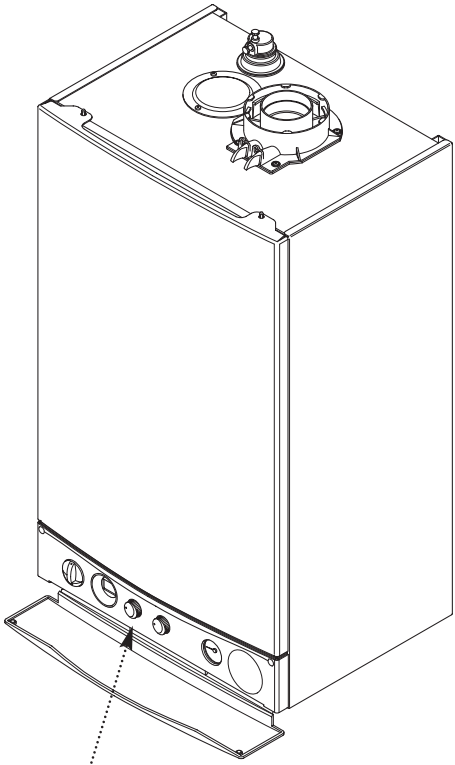

Boiler Controls - see opposite page for Operating Quick Reference Guide

© Baxi Heating UK Ltd 2008 All rights reserved. No part of this publication may be reproduced or transmitted in any form or by any means, or stored in any retrieval system of any nature (including in any database), in each case whether electronic, mechanical, recording or otherwise, without the prior written permission of the copyright owner, except for permitted fair dealing under Copyrights, Designs and Patents Act 1988.

Applications for the copyright owner's permission to reproduce or make other use of any part of this publication should be made, giving details of the proposed use, to the following address:

The Company Secretary, Baxi Heating UK Ltd, The Wyvern Business Park, Stanier Way, Derby, DE21 6BF.

Full acknowledgement of author and source must be given.

WARNING: Any person who does any unauthorised act in relation to a copyright work may be liable to criminal prosecution and civil claims for damages.







"Potterton" supports



Baxi Heating UK Ltd is a
BS-EN ISO 9001 Accredited Company

This product has an energy rating (A) on a scale of A to G. For more information see www.boilers.org.uk. This is a certification mark.

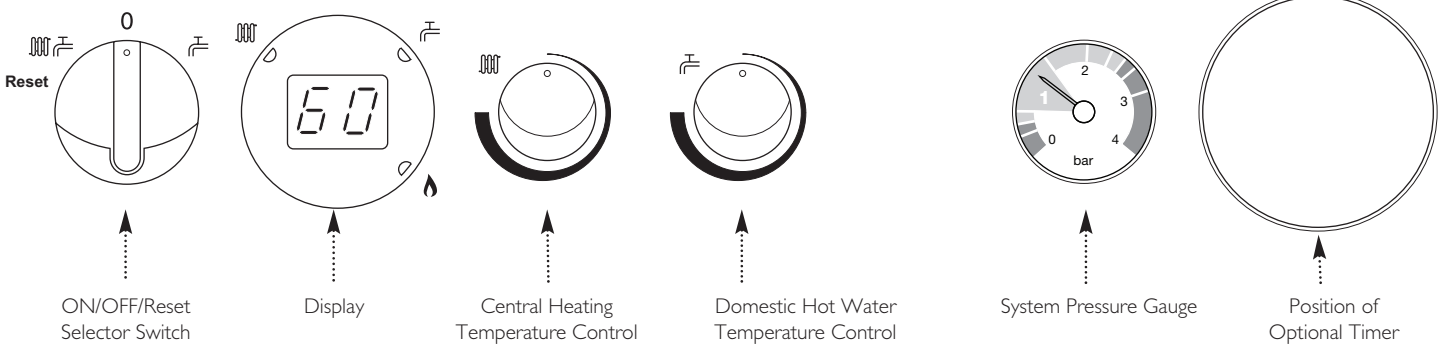
The code of practice for the installation, commissioning & servicing of central heating systems.



ON/OFF/Reset Selector Switch

Display

Central Heating Temperature Control

Domestic Hot Water Temperature Control

System Pressure Gauge

Position of Optional Timer

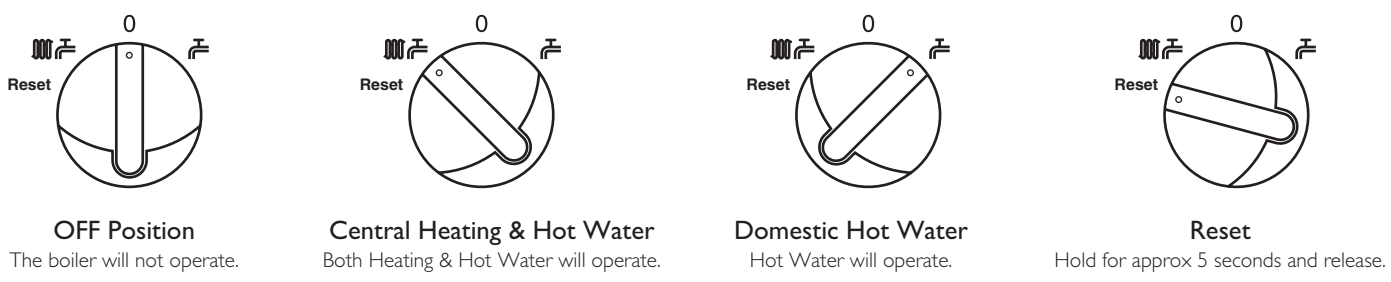

OFF Position
The boiler will not operate.

Central Heating & Hot Water
Both Heating & Hot Water will operate.

Domestic Hot Water
Hot Water will operate.

Reset
Hold for approx 5 seconds and release.

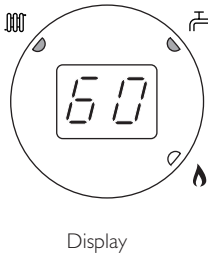

Display



Central Heating Indicator - The indicator will illuminate when the boiler is in the central heating mode.



Domestic Hot Water Indicator - The indicator will illuminate when hot water is being supplied to a tap or shower.



Burner On Indicator - The indicator will illuminate when the burner has fired and is heating your central heating or domestic hot water.

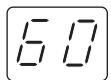

Boiler Output Temperature - In either the central heating or domestic hot water position the display will illuminate showing the current boiler temperature in degrees centigrade.

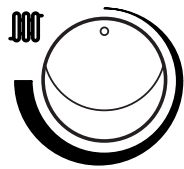

Central Heating Temperature Control
Turn the knob clockwise to increase or anticlockwise to decrease the temperature. Range 25 - 80° C.

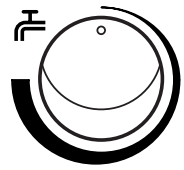

Domestic Hot Water Temperature Control
Turn the knob clockwise to increase or anticlockwise to decrease the temperature. Range 35 - 60° C.



Central Heating System Pressure - The normal operating water pressure is shown when the needle is in the GREEN section of the gauge, between 1 and 2.5 bar. If the pressure exceeds 3 bar (needle in the RED section) the safety pressure valve will operate and a fault is indicated. Contact your Installer.

2.0 Troubleshooting

Boiler not working

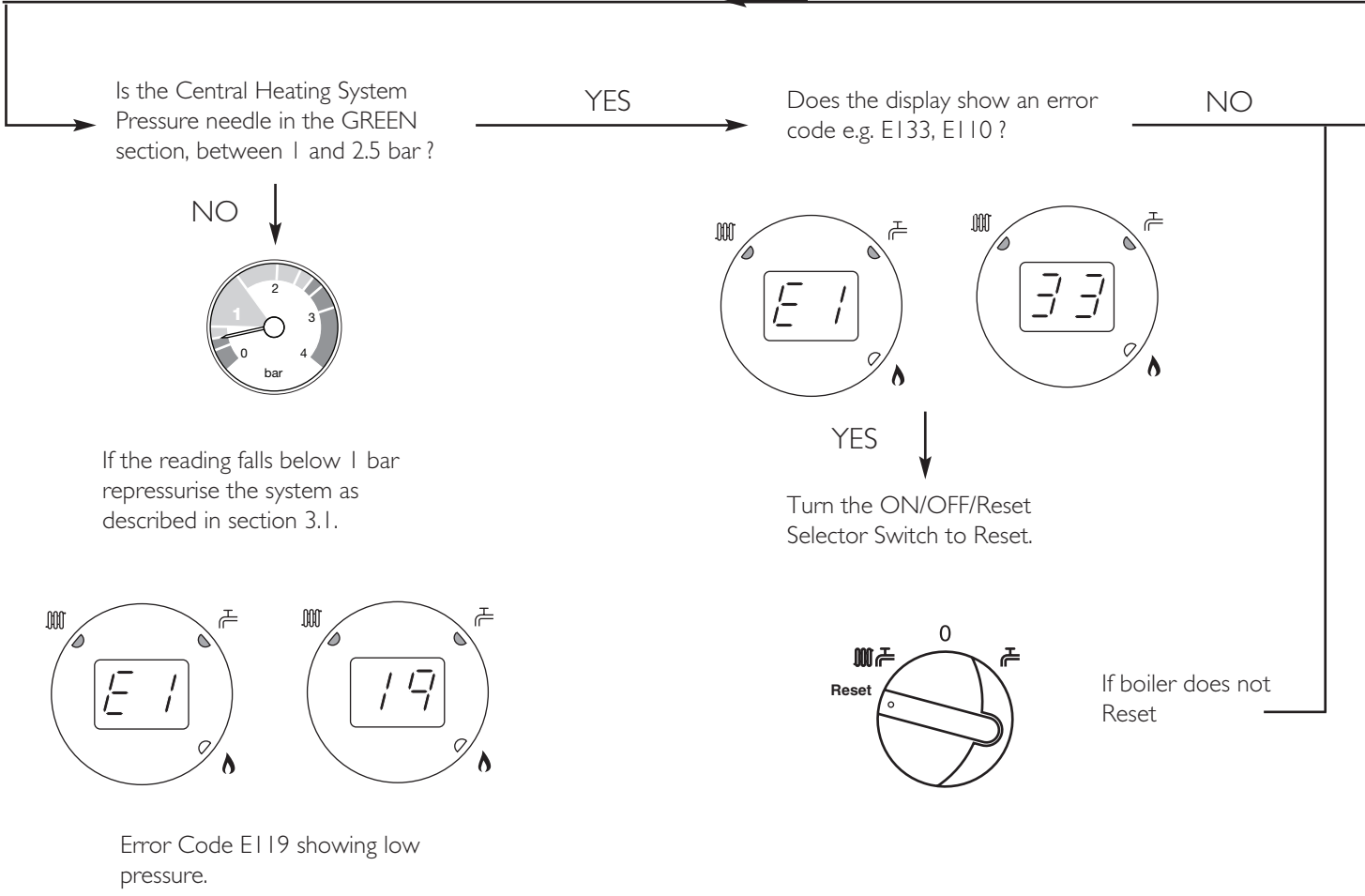
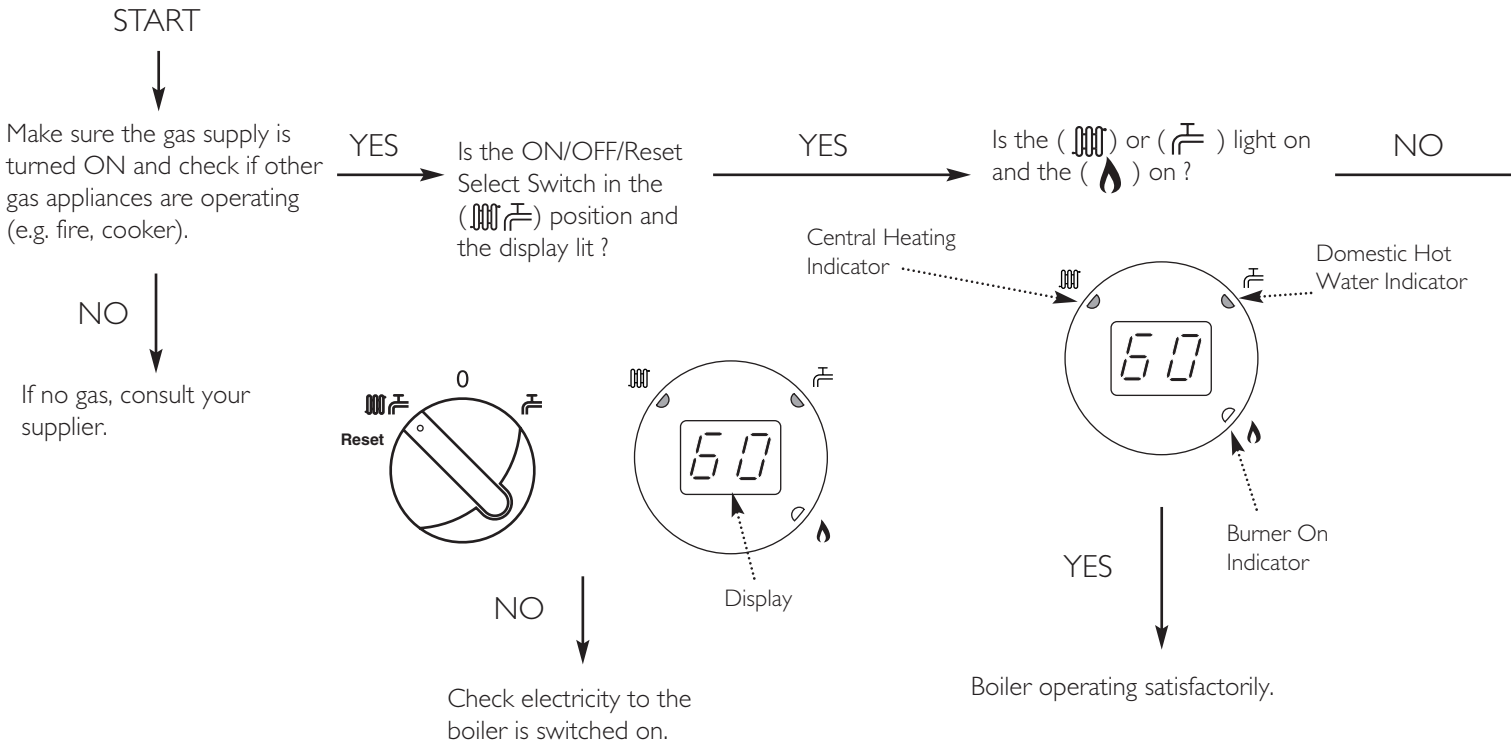

Is the Timer ON and calling for heat ?

YES

Is the Room Thermostat (if fitted) set high enough ?

YES

Typical examples of external timer

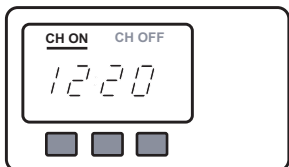
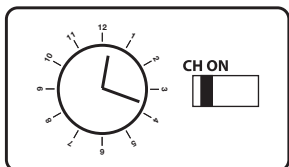

NO

Ensure timer is set for Central Heating ON (see any instructions supplied with timer).

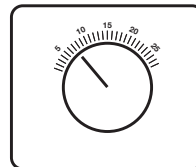

NO

Turn Room Thermostat to maximum setting (typical example shown).

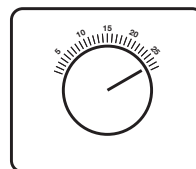

CONTACT YOUR INSTALLER OR SERVICE ENGINEER. Tell them the boiler is an LPG (Propane) model.

If you don't know what you need to do to get the boiler to light, or need help with the system and controls, contact your installer as soon as possible.

3.0 Repressurising System

3.1 Central Heating System Pressure

1. The water pressure in the central heating system is indicated by the pressure gauge.

2. With the system cold and the boiler not operating the pressure should be at least 0.5 bar. During operation the pressure should not exceed 2.5 bar, and will normally be between 1.0 and 2.0 (Fig. 1).

3. A pressure of 3 or greater indicates a fault. The safety pressure relief valve will operate, at a pressure of 3 (Fig. 3). **It is important that your Installer or Service Engineer is contacted as soon as possible.**

4. The minimum pressure for correct operation is 0.5. If the pressure falls below 0.5, this may indicate a leak on the central heating system (Fig. 2). Error Code E1 I9 will be shown on the display.

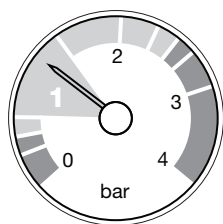

Fig. 1

Normal Pressure

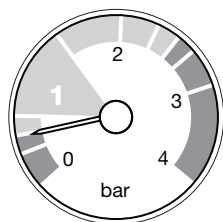

Fig. 2

Requires Re-pressurising

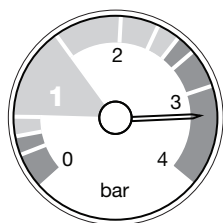

Fig. 3

Fault

3.2 To Re-Pressurise the System (Optional Filling Loop)

1. The procedure is for the optional filling loop kit when fitted. However, even if your boiler has an external loop, the principle is similar.

2. Look at the boiler from underneath. There will be two taps at the end of copper pipes, one with a blanking cap on the end. Do not operate these taps yet.

3. Your installer will have left a metal braided hose (the 'filling loop') with you for safe keeping.

4. This loop **MUST** be connected to the taps. Remove the blanking cap and set aside.

5. Connect the loop to the taps with the wing nuts. These should be hand tightened.

6. Carefully open the handles on both taps and check the boiler pressure gauge. Once the needle on the gauge is above the 0.5 mark both taps can be closed.

7. Undo the two wing nuts, remove the loop and refit the blanking cap. Put the loop in a safe place for future use.

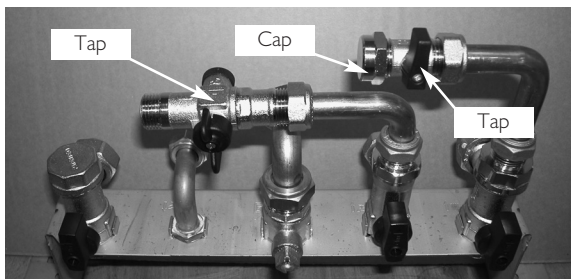

Boiler Taps & Connections, as viewed from underneath

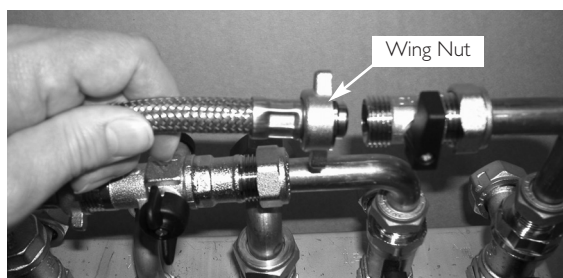

Wing Nut

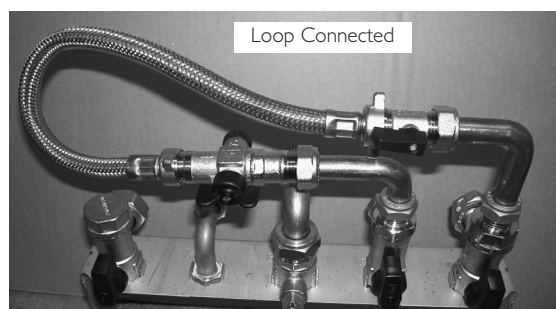

Loop Connected

4.0 Clearances

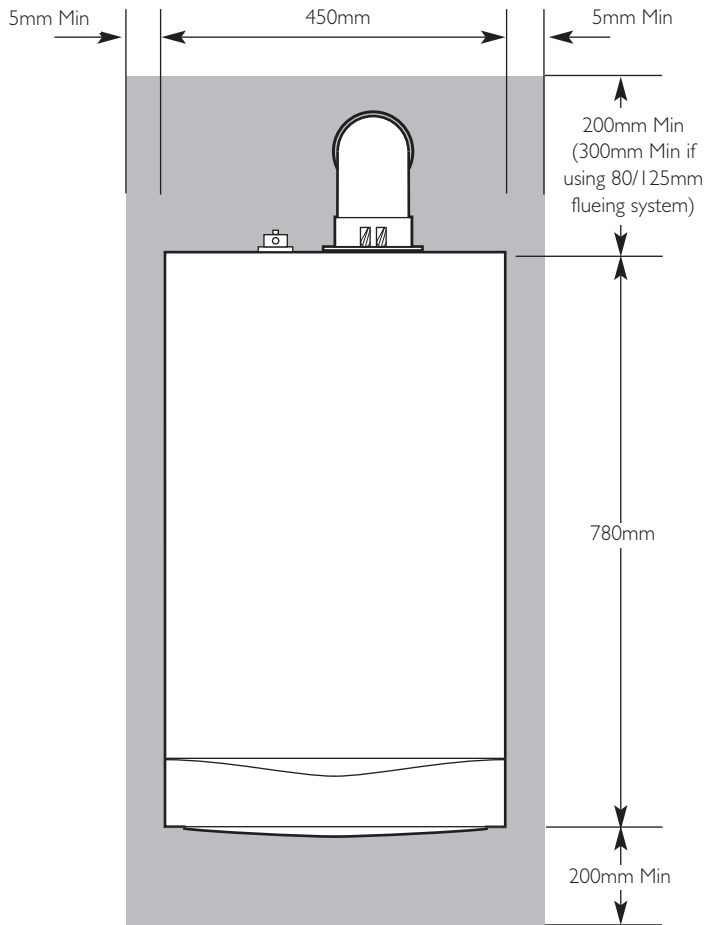

4.1 For your Safety

1. This appliance must have been installed in accordance with the manufacturer's instructions and the regulations in force.
2. Any modification that may interfere with the normal operation of the appliance without express written permission from the manufacturer or his agent could invalidate the appliance warranty. In GB this could also infringe the Gas Safety (Installation and Use) Regulations.

GB - Heating Industry definition meaning England, Scotland, Wales, Northern Ireland, Isle of Man and the Channel Isles

3. Your boiler must not be operated without the casing correctly fitted.
4. Do not interfere with any sealed components on this boiler.
5. Take note of any warning labels on your boiler.
6. Your boiler should have the following minimum clearances for Safety and Maintenance (Fig. 34):-

Top	- 200mm
Bottom	- 200mm
Left side	- 5mm
Right Side	- 5mm
Front	- 5mm (In Operation)
	- 450mm (For Servicing)

7. If your boiler is installed in a compartment, do not use it for storage purposes. Do not obstruct any purpose provided ventilation openings.
8. Flammable materials must not be stored in close proximity to your boiler.
9. Avoid skin contact when your boiler is in operation, as some surfaces may get hot e.g. pipework.
10. Ensure that the flue terminal, outside the house, does not become damaged or obstructed, particularly by foliage.
11. It is important that the condensate drain system is not blocked, modified or damaged in any way as this would affect the operation of your boiler. Your installer should have insulated any exposed pipework.

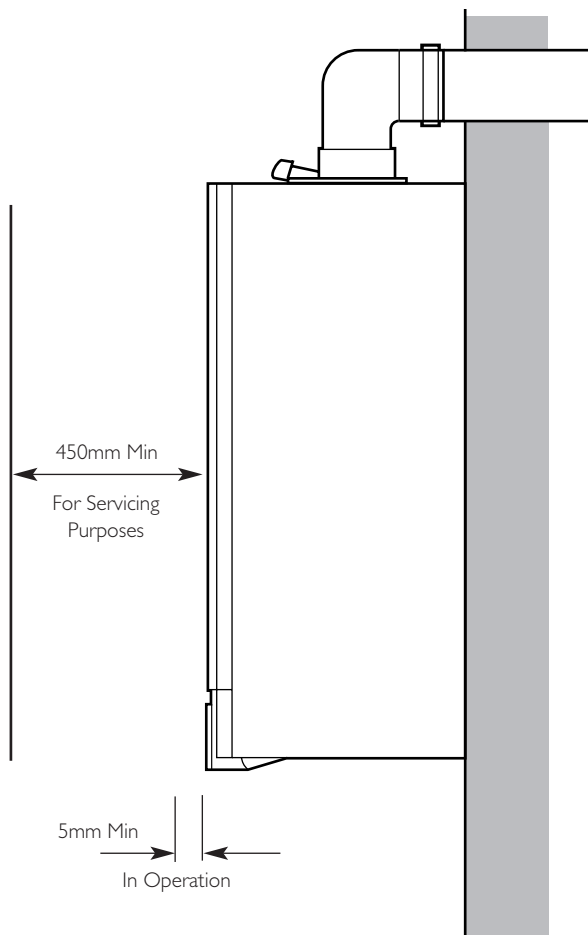

Fig. 4

5.0 Care of the Boiler

5.1 Cleaning the Outer case

The painted panels should be wiped with a damp cloth and then dried completely. **DO NOT USE ABRASIVE CLEANING AGENTS.**

5.2 Protection & Precaution

1. The boiler incorporates an integral frost protection feature that will operate in both modes. If the boiler temperature falls below 5° C, then the boiler will operate until the water temperature has been raised.
2. If a system frost thermostat has been fitted (your installer will be able to advise you), then to operate correctly and protect your system, the gas and electricity must be left on and the appliance set in the central heating mode.
3. The boiler incorporates an integral pump protection feature which continually monitors the time since the pump last operated. To prevent seizure, the pump will operate for approximately 1 minute if it has not run in the last 24 hours.

5.3 Fault Indication

1. If a fault occurs on the boiler an error code may be shown on the facia display (Fig. 5).
2. The codes are either two or three digit, preceded by the letter 'E'. For example, code E133 will be displayed by 'E1' alternating with '33'. E50 is shown as 'E' then '50'.
3. E20, E28, E50, E125 & E160 indicate faulty components. You should make a note of the displayed error code and contact your installer or service engineer.
4. If E110 or E130 is displayed overheat of the primary water or flue system has occurred. Turn the selector switch to the reset position and hold for at least 5 seconds. If the boiler does not relight, or the code is displayed regularly contact your installer or service engineer.

5. E119 is displayed when the primary water pressure is less than 0,5 bar. After repressurising the system the boiler should operate. Your installer will be able to advise you about the method of repressurising. See page 6 for further details.
6. E133 indicates that the gas supply has been interrupted, ignition has failed or the flame has not been detected. Ensure that the gas supply has not been turned off, and turn the selector switch to the reset position and hold for at least 5 seconds. If the boiler does not relight, or the code is displayed regularly contact your installer or service engineer.

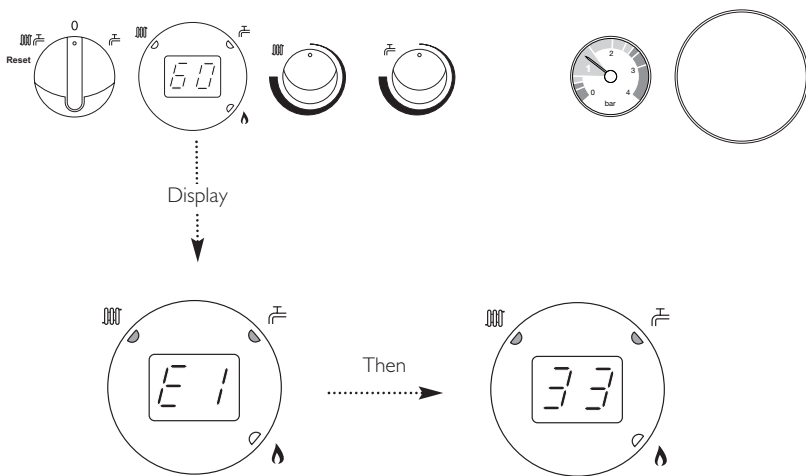

Fig. 5

Table of Error Codes

E20	Central Heating NTC Fault
E28	Flue NTC Fault
E50	Hot Water NTC Fault
E110	Safety Thermostat Operated
E119	Water Pressure Switch Not Operated
E125	Circulation Fault (Primary Circuit)
E130	Flue NTC Operated
E133	Interruption Of Gas Supply or Flame Failure
E160	Fan or Fan Wiring Fault

6.0 Legislation

6.1 Installation, Commissioning, Service & Repair

1. This appliance must be installed in accordance with the manufacturer's instructions and the regulations in force. Read the instructions fully before installing or using the appliance.
2. In GB, this must be carried out by a competent person as stated in the Gas Safety (Installation & Use) Regulations.
3. **Definition of competence:** A person who works for a CORGI registered company and holding current certificates in the relevant ACS modules, is deemed competent.
4. In IE (Eire), this must be carried out by a competent person as stated in I.S. 813 "Domestic Gas Installations".

All CORGI registered installers carry a CORGI identification card and have a registration number. You can check your installer is registered by telephoning 0800 915 0485 or writing to:-

1 Elmwood,
Chineham Park,
Crockford Lane,
Basingstoke. RG24 8WG.

or check online at www.trustcorgi.com

The boiler meets the requirements of Statutory Instrument "The Boiler (Efficiency) Regulations 1993 No 3083" and is deemed to meet the requirements of Directive 92/42/EEC on the energy efficiency requirements for new hot water boilers fired with liquid or gaseous fuels:-

Type test for purpose of Regulation 5 certified by:
Notified Body 0085.

Product/Production certified by:
Notified Bodies 0086.

For GB/IE only.

6.2 Benchmark Commissioning Checklist

1. Please ensure that your installer hands you the boiler Installation & Service Instructions with the "Benchmark Commissioning Checklist" sections completed. The details in the Checklist will be required in the event of any warranty work. Keep the instructions in a safe place and ensure that the Service Interval Record at the back is completed at each service visit.

Warning !

IMPORTANT

This boiler operates on LPG (Propane). Familiarise yourself with any control and isolation valves. If in doubt consult your installer about the operation of these devices.

If you smell gas

Turn off the gas supply and call your gas supplier immediately. It is possible to isolate the boiler at the isolating valve (Fig. 6).

Faulty boiler

If it is known or suspected that a fault exists on the boiler, it must not be used until the fault has been corrected by a competent person.

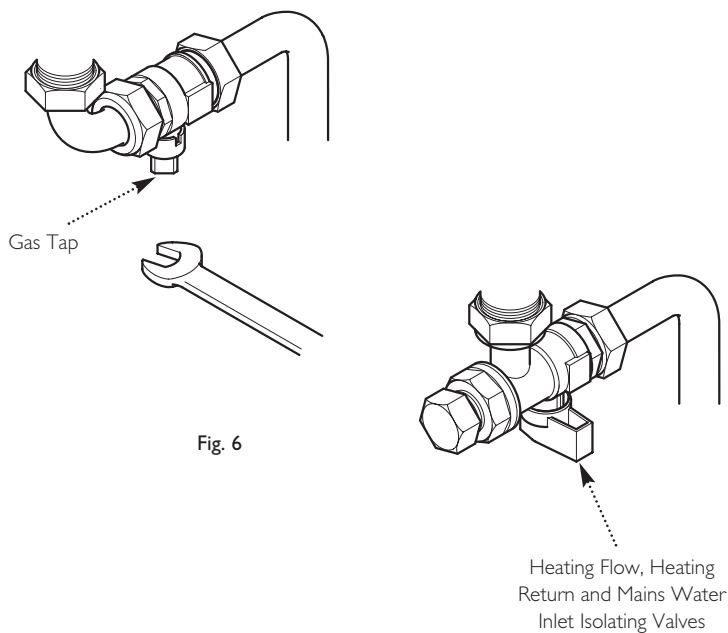

Fig. 6

In an Emergency

If a water or gas leak occurs or is suspected, the boiler can be isolated at the inlet valves as follows:

1. Using a suitable open ended spanner, turn the square nut on the gas tap through 90° (1/4 turn) to isolate the gas supply at the boiler (Fig. 6).
3. The water isolating valves are positioned under the boiler and can be closed by turning their taps to the right towards the wall (Fig. 6).
4. Call your Installer or Service Engineer as soon as possible.

Please complete the boxes below

Serial Number

Date of Installation

D	D	M	M	Y	Y

Installer Details (name, address and contact number(s))

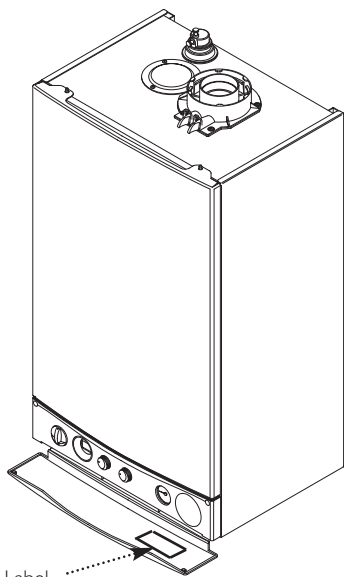

All descriptions and illustrations provided in this leaflet have been carefully prepared but we reserve the right to make changes and improvements in our products which may affect the accuracy of the information contained in this leaflet. All goods are sold subject to our standard Conditions of Sale which are available on request.

POTTERTON
 A Trading Division of Baxi Heating UK Ltd (3879156)
 A Division of Baxi Group
 Brooks House, Coventry Road, Warwick. CV34 4LL
 After Sales Service 08706 017 017 Technical Enquiries 08706 049 049
 Website www.potterton.co.uk
 e&oe

A BAXI GROUP company

© Baxi Heating UK Ltd 2008

9.0 Warranty & Service

Standard Warranty Term & Conditions

12 Months Free Warranty - register today

To receive your 12 months free warranty please complete the form supplied with the boiler or simply call **heateam**, the service of Baxi Heating UK Ltd on **08706 000 653**.

Our promise to you

If you experience a fault with your new boiler, we aim to provide a safe and high quality repair service supported by our dedicated national network of highly skilled engineers. If your installer can't resolve the problem for you, we will do everything we can to get an engineer out to you as quickly as possible. Nothing in this warranty will affect your statutory consumer rights.

What you need to do if you experience a problem with your heating system or the operation of the boiler

You should always contact your installer first, because the fault may not be related to the boiler. If your installer confirms that the fault is within the boiler itself and he/she can't repair it, our friendly customer service team is on hand to help. Simply call our service division **heateam** on **08706 017 017** to book an engineer visit or for any general advice that you may need. Our contact centre is open Monday to Friday 8am - 6pm, weekends and Bank Holidays 8.30am - 2pm, excluding Christmas Day and New Years Day.

When calling **heateam** it would be helpful if you could have the following information to hand:-

- 1 boiler serial number (see opposite).
- 2 boiler make and model number.
- 3 Your installer name and address details.
- 4 Proof of purchase (if you do not have the boiler serial number).

What this warranty covers

Free of charge repair or replacement of components found to be faulty from manufacture.

Free of charge replacement of the complete unit provided always that the failure is related to a manufacturing fault that cannot be repaired or is uneconomic to repair.

The warranty runs for 12 months from the date your product is installed.

What this warranty does not cover

Repairs to boilers which haven't been installed and commissioned properly, and as set out in the installation instructions (this includes the need to flush the system effectively and add a suitable corrosion inhibitor).

Any damage caused by hard water scale deposits and/or aggressive water resulting from corrosion.

Any other defects or failures, either in the connected heating system or outside of the boiler itself.

Faults caused by inadequate supply of electricity, gas or water to the property.

Installations within commercial settings for which this boiler was not designed.

Reimbursement of any third party repair or replacement costs that we haven't been told about or agreed with you in advance.

Compensation for consequential losses (e.g. loss of earnings, business losses, stress and inconvenience) arising from a production breakdown, including repair delays caused by factors outside our reasonable control.

Annual Service

To ensure you receive the maximum efficiency from your boiler we recommend your boiler has an annual service so you and your family can continue to enjoy heating and hot water comfort.

To arrange an annual service from one of our Baxi Heating UK Ltd heating experts, please call 08706 096 096