

# IDEAL COMPACT EXTRA

## Wall mounted, Balanced Flue Gas Boiler.

### User's Instructions.

**CAUTION:** To avoid the possibility of injury during the operation or cleaning of this appliance, care should be taken when handling edges of sheet steel components.

G.C. Appliance No. 41 421 52

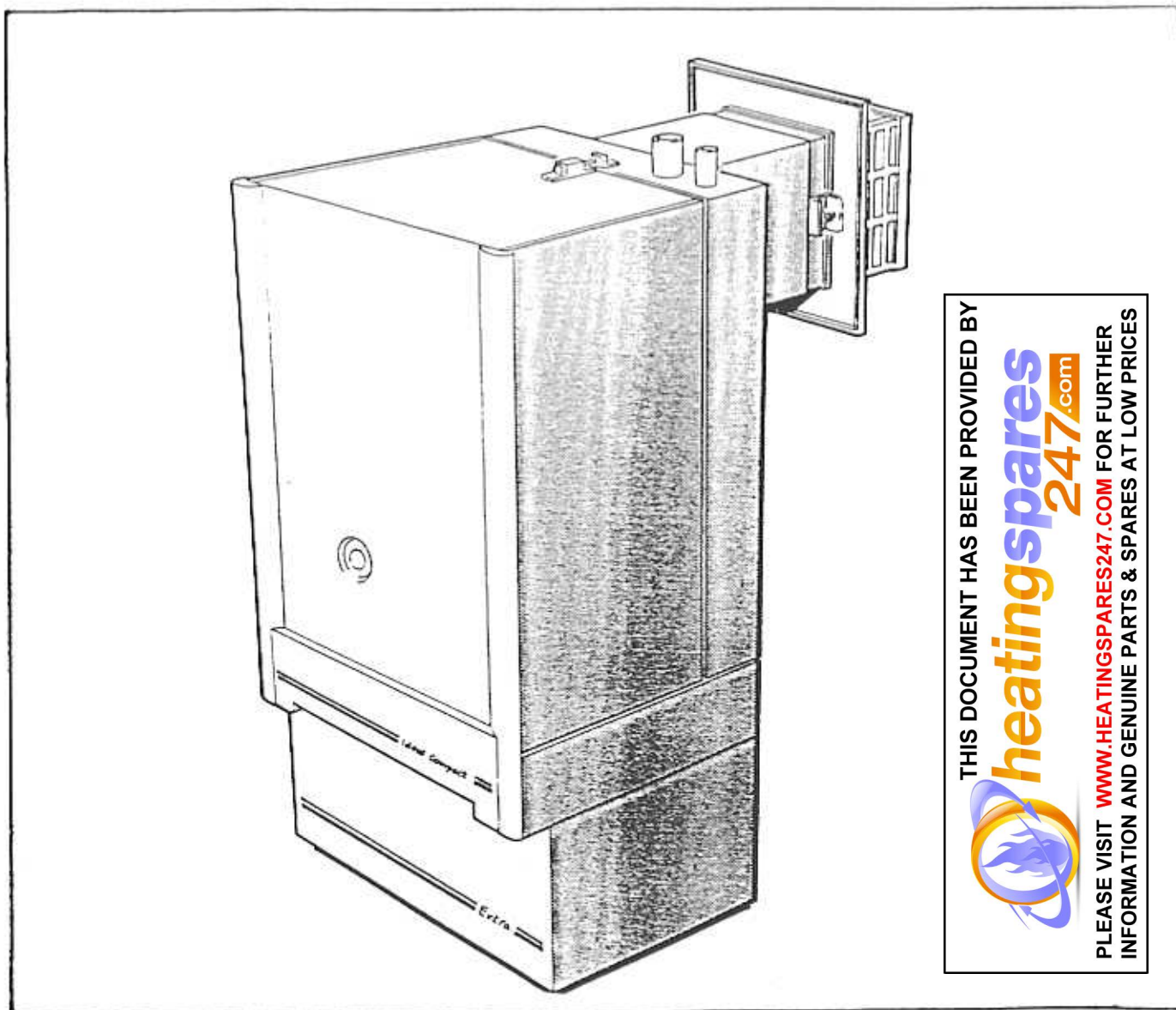

THIS DOCUMENT HAS BEEN PROVIDED BY  
**heatingspares247.com**  
PLEASE VISIT [WWW.HEATINGSPPARES247.COM](http://WWW.HEATINGSPPARES247.COM) FOR FURTHER  
INFORMATION AND GENUINE PARTS & SPARES AT LOW PRICES

The Gas Safety [Installation & Use] Regulations: 1984 impose certain statutory obligations on gas users. Further information may be obtained on application to the Gas Region.

It is law that all gas appliances are installed by competent persons e.g. CORGI [identified by ] in accordance with the above regulations.

Failure to install appliances correctly could lead to prosecution. It is in your own interest, and that of safety, to ensure that the law is complied with.

#### ELECTRICAL SUPPLY.

The boiler is supplied with a pre-wired mains cable complete with a three pin plug, but if another mains plug has to be connected for any reason it MUST be a 3-pin type, wired as shown in Fig. 1, and fused at 3A.

*The appliance MUST be efficiently earthed.*

As the colour of the wires in the mains lead of the appliance may not correspond with the coloured markings identifying the terminals in your plug, proceed as follows:

The wire which is coloured GREEN and YELLOW must be connected to the terminal in the plug which is marked with the letter E or by the symbol  or coloured GREEN or GREEN and YELLOW.

The wire which is coloured BLUE must be connected to the terminal which is marked with the letter N or coloured BLACK.

The wire which is coloured BROWN must be connected to the terminal which is marked with the letter L or coloured RED.

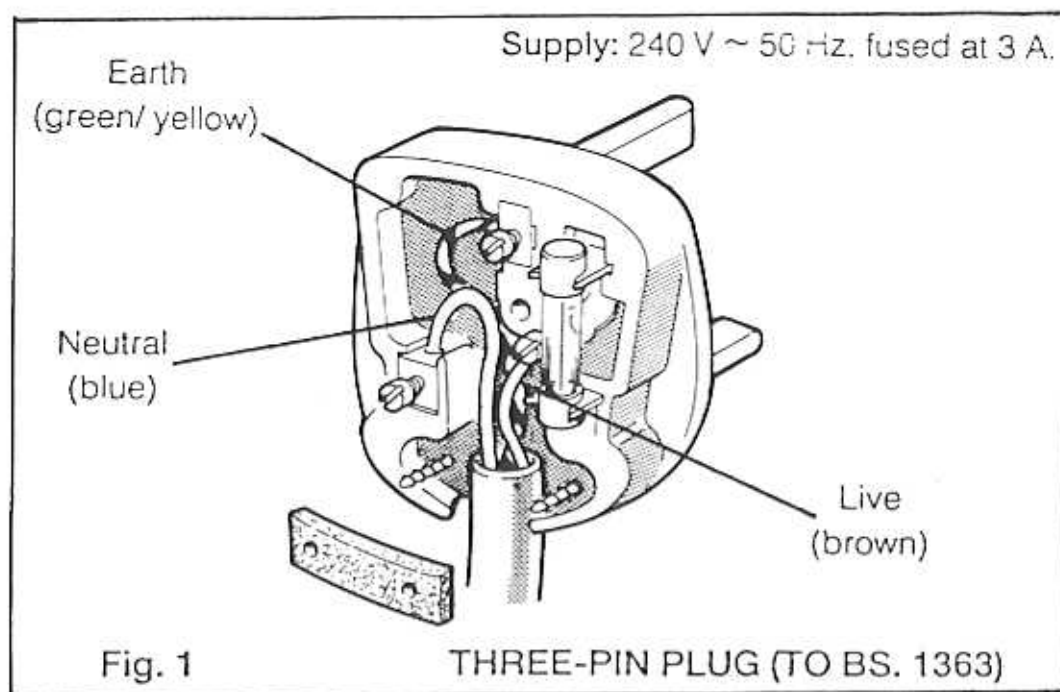

## MINIMUM CLEARANCES

The minimum clearances given in Table 1 MUST be complied with in order to maintain the safe running of the boiler, and to facilitate servicing.

Table 1

Above the boiler	mm	100
	in	4
At each side of the boiler	mm	10
	in	3/8
Underneath the boiler	mm	100
	in	4

In addition, a MINIMUM clearance of 450mm [18in.] MUST be available at the front of the boiler for servicing.

**IMPORTANT:** THIS APPLIANCE MUST NOT BE OPERATED WITHOUT THE CASING CORRECTLY FITTED.

## NOTES:

- [a] If the boiler is installed in a compartment then the compartment MUST NOT be used for storage purposes.
  - [b] The ventilation provided for the boiler during installation MUST NOT be blocked and a check should be made periodically that the ventilation areas are free from any obstruction.
  - [c] If it is known or suspected that a fault exists on the boiler it MUST NOT be used until the fault has been correct by a competent person.
- It is essential that the instructions in this booklet are strictly followed for safe and economic operation of the boiler.

TO LIGHT THE BOILER , Refer to Fig. 2.

1. Check that the electricity supply to the boiler is OFF.
2. Pull off the controls compartment door.
3. Push in the gas control knob [B] and turn it CLOCKWISE to the OFF [ ● ] position.
4. Turn the gas control knob [B] ANTICLOCKWISE to the PILOT [ ✱ ] position.
5. Push in and retain fully depressed the gas control knob [B]. Press and release the ignition button [C] repeatedly until the pilot flame can be seen through the sightglass [A]. When the pilot has lit continue to press in the gas control knob [B] for a further 15 seconds.
6. Should the pilot go out at this or any other stage, push in the gas control knob [B] and turn it CLOCKWISE to the OFF [ ● ] position. Wait for three minutes and then repeat instructions 4 & 5 above but wait longer than 15 seconds before releasing the gas control knob.
7. Switch ON the electricity supply to the boiler and check that the room cylinder temperature controllers [D] and [E] are calling for heat, i.e. are turned fully CLOCKWISE.
8. Set the clock [F], Refer to instructions - SETTING THE CLOCK.
9. Turn the gas control knob [B] ANTICLOCKWISE to the MAIN BURNER [ ◆ ] position, and the boiler will light.
10. Refit the controls compartment door.

## OPERATION

### 1. WINTER CONDITIONS

Set the room and cylinder temperature controllers [D] and [E] to the required temperatures. The boiler will supply domestic hot water until satisfied, and then will supply the central heating.

### 2. SUMMER CONDITIONS.

Set the room temperature controller (D) to minimum, i.e. fully ANTICLOCKWISE, and the cylinder controller (E) to the required temperature. The boiler will supply Domestic Hot Water ONLY (as long as the room temperature is greater than approximately 5°C).

### TO SHUT DOWN THE BOILER

#### 1. FOR SHORT PERIODS

Turn the gas control knob (B) CLOCKWISE to the PILOT( \* ) position.

When heating and/or hot water are again required, return the knob to its original MAIN BURNER ( ♦ ) position.

#### 2. FOR LONGER PERIODS

- (a) Push in the gas control knob [B] and turn it CLOCKWISE to the OFF [ ● ] position to extinguish the pilot burner.
- (b) Switch the electricity supply to OFF.

**Note:** On restoration of the electricity supply it will be necessary to re-set the clock.

**WARNING:** If no frost protection is provided and frost is likely during a short absence from home leave the heating controls at a reduced temperature setting.

For longer periods, the entire system should be drained, including the domestic hot water supply.

### BOILER OVERHEAT THERMOSTAT (Fitted for sealed systems ONLY)

If the boiler is fitted with a safety cut-out thermostat, the stat will extinguish the main burner and pilot in the event of overheating. Should this occur, allow the boiler to cool and then relight as detailed under 'To Light the Boiler'. If the cut-out condition still persists then turn OFF the boiler and consult your Local Heating Installer.

## CONTROL OF WATER TEMPERATURE

1. The boiler thermostat automatically switches the main burner OFF and ON to maintain the preset temperature.
2. The pilot burner remains alight continuously to give re-ignition to the main burner.

## TO RELIGHT THE BOILER

Repeat the procedure 1 to 10 detailed in 'To Light the Boiler'.

## ESCAPE OF GAS

Should a gas leak be suspected contact your Local Gas Region without delay.

## CLEANING

For normal cleaning simply dust with a dry cloth.  
To remove stubborn marks and stains wipe with a damp cloth and finish off with a dry cloth.  
Do NOT use abrasive cleaning materials.

## MAINTENANCE

The appliance should be SERVICED AT LEAST ONCE A YEAR by a qualified Heating Engineer or your Local Gas Region.

**BOILER CONTROLS**

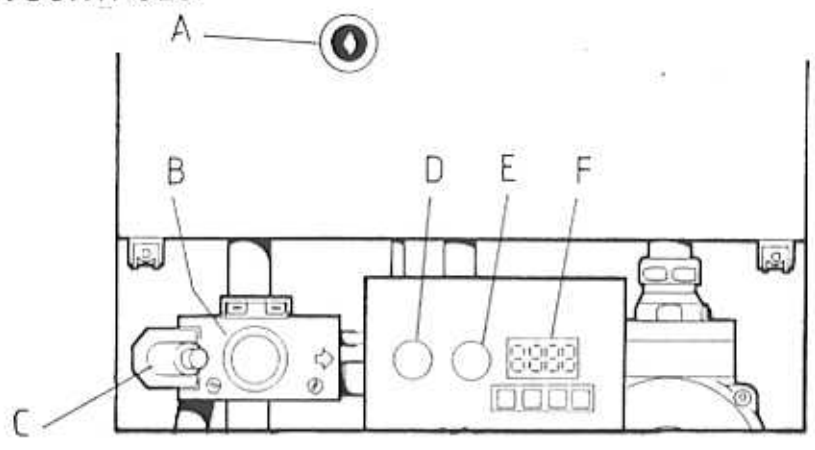

**LEGEND**

- A Sight glass
- B Gas control knob
- C Piezo ignition button
- D Room temperature controller
- E Cylinder temperature controller
- F Clock

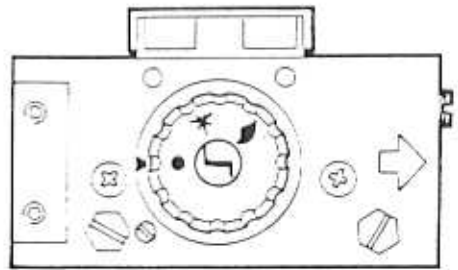

OFF

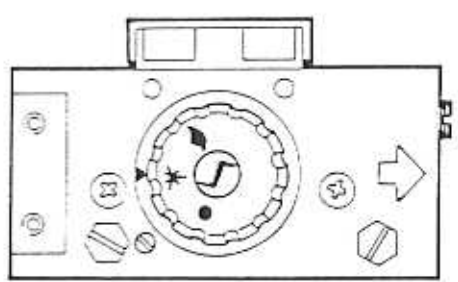

PILOT

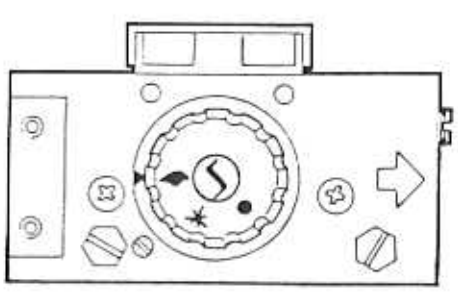

MAIN BURNER

### SETTING THE CLOCK

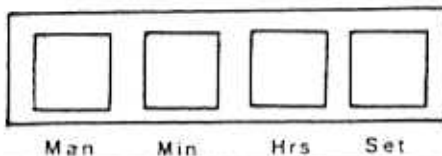
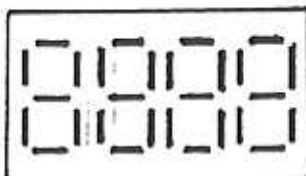

#### 1. ACTIVATION

Press SET and MAN together - the colon will flash on and off.



#### 2. SETTING TIME

(a) Press SET, colon stops flashing 'T' appears



(b) Press HRS and set hours to correct time, then press MIN and set minutes to correct time.

N.B. When buttons are pressed for more than 2 seconds, figures advance rapidly.

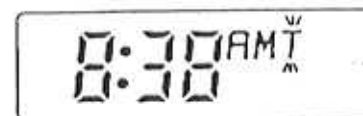

#### 3. SETTING PROGRAMMES

(a) Programme 1

i. To programme switch-on time, press SET.

Display appears as illustrated with '1 ON' flashing.

Set required Switch-On time by pressing HRS and MIN buttons as described in 2(b).

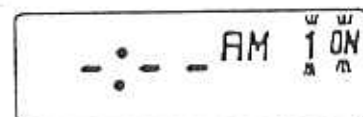

ii. To programme Switch-Off time press SET.

Display appears as illustrated with '1 OFF' flashing.

Set required Switch-Off time by pressing HRS and MIN buttons as described above.

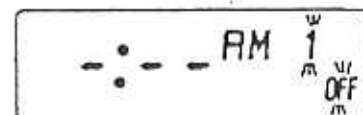

SETTING THE CLOCK - Continued

(b) Programmes 2 and 3

i. Press SET.

Display appears with '2 ON' flashing

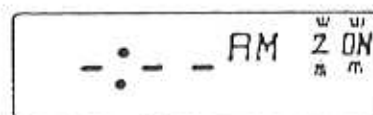

ii. Programme On and Off times as described for setting in Programme 1.

iii. Press SET again and display appears with '3 ON' flashing

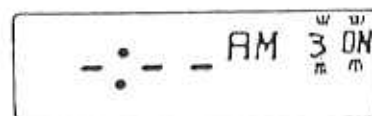

Note: To omit Programme 3 press SET twice

iv. Programme On and Off times as described for setting in Programme 1.

v. Finally press SET again, this will return the time to its normal operating mode and the correct time will be displayed with the colon flashing.

4. TO REVIEW SETTING

Press SET button. Each time the button is pressed the display shows the next stage of the programmed sequence. The part of the display which is flashing shows the stage of the programme displayed, e.g. 1 ON flashing means the first ON time is shown. Continue pressing SET button to return to normal operating mode.

5. MANUAL OVERRIDE

To switch on the appliance when the display is in Off mode, press MAN - the 'ON' on the display will flash to show the switch is not in its programmed position. To return to 'Off' press the MAN button again.

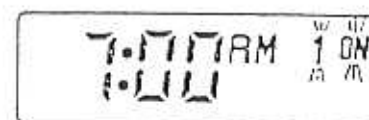

6. SUSPEND

To suspend previously set On and Off times, press SET button until the setting to be suspended is reached. Press MAN button, an 'X' will appear on the display to show this setting has been suspended. Press MAN again to cancel suspend. Return display to normal operation by pressing SET until this is reached.



SETTING THE CLOCK - Continued

7. CLEAR

To clear all programmes, press SET and MAN buttons together.  
The switch may then be reset as shown in 1 & 2.

8. REMEMBER

- (a) When programming, you must fully complete the sequence by repeatedly pressing the SET button until the colon between hours and minutes flashed indicating that the unit is in the normal operating mode. this applied even if you are only using 1 (or 2) ON/OFF programmes.

(b) Normal Operation

The flashing colon shows that the switch is in normal operating condition and will always display the correct time (unless you have set it incorrectly).



'ON' shows that it has switched on at a programme setting.

(c) Manual Override

The 'OFF' is flashing to indicate that a previous programme has been overridden and the switch is now Off. It will revert to its normal programmed operation at the next setting.

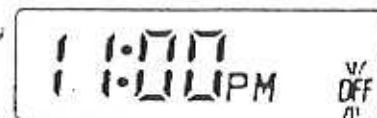

(d) Suspend

The 'X' shows that a programme instruction has been suspended.

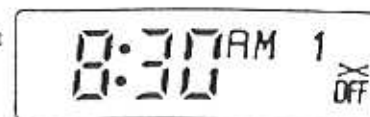

(e) Setting or Review

If the colon between hours and minutes is stationary you are in the programming condition. After pressing SET, the '2OFF' flashing on the display indicates that the second Off time is being shown and may be altered if required.

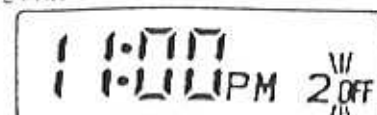



THIS SYMBOL IS YOUR  
ASSURANCE OF QUALITY

These appliances are designed for use with Natural Gas only. They have been tested and conform with the provisions of BS 6332 & BS 5258.

Products bearing this Kitemark are made to a safety and performance standard under a stringent scheme of supervision and control monitored by the British Standards Institute

**STELRAD GROUP** pursues a policy of continuing improvement in design and performance of its products. The right is therefore, reserved to vary specification without notice.

**STELRAD GROUP** Limited

Sales and Marketing

Accord House, Goulton Street

Kingston upon Hull.

North Humberside. HU3 4DJ

Telephone: 0482 223673 Telex: 592786

Head and Registered Office;

Newtown Road, HENLEY-on-Thames. Oxfordshire

RG9 1HL

Registration No. London 322137

A SUBSIDIARY OF METAL BOX p.l.c.

H.0692 1/89

Printed in England.

 **Stelrad**! Ideal